



# techhose

QUALITY CONNECTIONS

Hydraulics

Pneumatics  
& Vacuum

Industrial

Compressed Air  
& Ring Main

Process &  
Instrumentation

---

## Monitor & Test

---

**1** Hydraulics **3-284**

**2** Hydraulic Quick Release Couplings **285-320**

**3** Pneumatic Quick Release Couplings **321-406**

**4 Monitor & Test** **407-446**

**5** Pneumatic & Vacuum **447-762**

**6** Push-in Fittings & Tubing **763-918**

**7** Valves & Actuation **919-1060**

**8** Ring Main **1061-1136**

**9** Hose Tails, Adaptors, Fittings & Manifolds **1137-1224**

**10** Stainless Steel **1225-1332**

**11** Malleable Iron **1333-1398**

**12** Hose, Couplings, Ducting & Hose Reels **1399-1510**

**13** Clips & Clamps **1511-1558**

**14** Paint, Sprays & Adhesives **1559-1590**

**15** Blow Guns, Vacuum & Nozzles **1591-1616**

**16** Fuelling, Lubrication, Wash Down & Misting **1617-1696**

**17** Compressors & Air Tools **1697-1726**

**18** Hand Tools & PPE **1727-1765**

# SECTION 4

## Monitor & Test

4

---

**4.01** Pressure Gauges **409-418**

**4.02** Temperature & Pressure Switches **419-429**

**4.03** Industrial Filtration **430-435**

**4.04** Sight Glasses & Flow Switches **436-445**

**4.05** Thermometers for Industry **446**

---

## 4.01 Pressure Gauges



409-418

- Dry Pressure Gauges & Accessories
- Glycerine Gauges & Accessories
- Temperature Gauges
- HVAC Gauges & Accessories



## 4.02 Temperature & Pressure Switches



419-429

- Digital Flow Pressure Sensors
- Temperature Switches
- Pressure Transducers
- Adjustable Pressure Switches
- Pressure Switches
- Vacuum Switches
- Flow Sensors
- Pressure Sensors



## 4.03 Industrial Filtration



430-435

- Filters & Drains (Air, Water & Vacuum)
- Condensate Management
- Air Receivers & Accessories
- Reservoir Tanks
- Compressor Oil



## 4.04 Sight Glasses & Flow Switches



436-445

- Sight Glasses & Indicators
- Flow Switches
- Flow Indicators
- Variable Area Flow Meters
- Flow Meters
- Float Level Switches
- Liquid Level Gauges
- Visual Indicators
- Cold Water Flow Meters

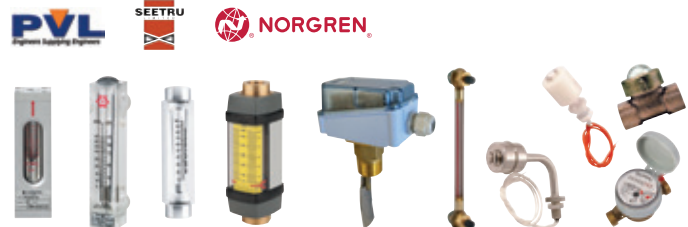

## 4.05 Thermometers for Industry



446

- K Type Handheld Thermometers
- K Type Probes
- Room Thermometers
- Bimetal Indicators
- Dial Pipe Thermometers
- Magnetic Dial Thermometers





## Dry Pressure Gauges

**FT Pro** dry gauges are a market leading range offering a reliable solution for pressure monitoring within pneumatic systems.

Used extensively throughout the world's manufacturing facilities, all units have been 100% pressure tested and inspected, so quality can be guaranteed.

### Applications:

- Construction
- Chemical
- Agriculture
- Offshore
- Mining
- Automotive
- OEM machine
- Rail building
- Industrial





# DRY GAUGES



## Steel Case, Centre Back Connection

- Robust metal case
- Brass thread
- BSP taper



### BSPT Brass Connection

0021	Thread	Gauge Diameter mm	Pressure Range PSI	Pressure Range Bar
2018-1681	1/8"	40	0-15	0-1
2018-1699	1/8"	40	0-30	0-2
2018-1707	1/8"	40	0-60	0-4
2018-1723	1/8"	40	0-100	0-6
2018-1731	1/8"	40	0-160	0-10
2018-1749	1/8"	40	0-200	0-12
2018-1756	1/8"	40	0-300	0-20
2018-1764	1/8"	50	0-15	0-1
2018-1772	1/8"	50	0-30	0-2
2018-1780	1/8"	50	0-60	0-4
2018-1798	1/8"	50	0-100	0-6
2018-1806	1/8"	50	0-160	0-10
2018-1814	1/8"	50	0-200	0-12
2018-1822	1/8"	50	0-300	0-20

Tech Sheet 20581

### BSPT Brass Connection

0236	Thread	Gauge Diameter mm	Pressure Range PSI	Pressure Range Bar
PGR050114	1/4"	50	0-15	0-1
PGR050314	1/4"	50	0-30	0-2
PGR050414	1/4"	50	0-60	0-4
PGR050614	1/4"	50	0-100	0-6
PGR051014	1/4"	50	0-160	0-10
PGR051214	1/4"	50	0-200	0-12
PGR052014	1/4"	50	0-300	0-20
PGR060114	1/4"	63	0-15	0-1
PGR061014	1/4"	63	0-160	0-10
PGR061214	1/4"	63	0-200	0-12
PGR062014	1/4"	63	0-300	0-20

Tech Sheet 20581

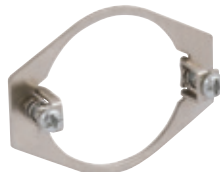

### Panel Mount Brackets, to suit Steel Dry Gauges

0338	To Suit mm
KPMB40R	40
KPMB50R	50

## ABS Case, Bottom Connection



### BSPT Brass Connection

0021	Thread	Gauge Diameter mm	Pressure Range PSI	Pressure Range Bar
G50-01B	1/8"	50	0-15	0-1
G50-02B	1/8"	50	0-30	0-2
G50-04B	1/8"	50	0-60	0-4
G50-06B	1/8"	50	0-100	0-6
G50-10B	1/8"	50	0-160	0-10
G50-12B	1/8"	50	0-200	0-12
G50-01C	1/4"	50	0-15	0-1
G50-02C	1/4"	50	0-30	0-2
G50-025C	1/4"	50	0-40	0-2.5
G50-04C	1/4"	50	0-60	0-4
G50-06C	1/4"	50	0-100	0-6
G50-10C	1/4"	50	0-160	0-10
G50-12C	1/4"	50	0-200	0-12
G50-16C	1/4"	50	0-250	0-16
G63-01D	1/4"	63	0-15	0-1
G63-04D	1/4"	63	0-60	0-4
G100-04B	3/8"	100	0-60	0-4
G100-06B	3/8"	100	0-100	0-6
G100-10B	3/8"	100	0-160	0-10
G100-14B	3/8"	100	0-200	0-14

Tech Sheet 20582

## ABS Case, Centre Back Connection



### BSPT Brass Connection

0021	Thread	Gauge Diameter mm	Pressure Range PSI	Pressure Range Bar
G40-01R	1/8"	40	0-15	0-1
G40-02R	1/8"	40	0-30	0-2
G40-04R	1/8"	40	0-60	0-4
G40-06R	1/8"	40	0-100	0-6
G40-07R	1/8"	40	0-100	0-7
G40-10R	1/8"	40	0-160	0-10
G40-12R	1/8"	40	0-200	0-12
G40-16R	1/8"	40	0-250	0-16
G40-20R	1/8"	40	0-300	0-20
G50-01R	1/8"	50	0-15	0-1
G50-02R	1/8"	50	0-30	0-2
G50-04R	1/8"	50	0-60	0-4
G50-06R	1/8"	50	0-100	0-6
G50-10R	1/8"	50	0-160	0-10
G50-12R	1/8"	50	0-200	0-12
G50-16R	1/8"	50	0-250	0-16
G50-20R	1/8"	50	0-300	0-20
G50-02T	1/4"	50	0-30	0-2
G50-04T	1/4"	50	0-60	0-4
G50-06T	1/4"	50	0-100	0-6
G50-10T	1/4"	50	0-160	0-10
G50-12T	1/4"	50	0-200	0-12
G50-16T	1/4"	50	0-250	0-16
G50-20T	1/4"	50	0-300	0-20
G63-10T	1/4"	63	0-160	0-10
G63-12T	1/4"	63	0-200	0-12
G63-16T	1/4"	63	0-250	0-16

Tech Sheet 20584

All pressure gauges can be supplied with a calibration certificate at a nominal charge. Please call our Business Development Team for price and delivery.

## Pressure Gauge Bottom Entry, Steel Case



### BSPT Brass Connection

0236	Thread	Gauge Diameter mm	Pressure Range Bar
PGB050118	1/8"	50	0-1
PGB050318	1/8"	50	0-2
PGB050418	1/8"	50	0-4
PGB050618	1/8"	50	0-6
PGB051018	1/8"	50	0-10
PGB051418	1/8"	50	0-14
PGB052018	1/8"	50	0-20
PGB050114	1/4"	50	0-1
PGB050314	1/4"	50	0-2
PGB050414	1/4"	50	0-4
PGB050614	1/4"	50	0-6
PGB051014	1/4"	50	0-10
PGB051214	1/4"	50	0-12
PGB051414	1/4"	50	0-14
PGB052014	1/4"	50	0-20
PGB060114	1/4"	63	0-1
PGB060314	1/4"	63	0-2
PGB060414	1/4"	63	0-4
PGB061014	1/4"	63	0-10
PGB061214	1/4"	63	0-12
PGB062014	1/4"	63	0-20
PGB100138	3/8"	100	0-1
PGB100338	3/8"	100	0-2
PGB100438	3/8"	100	0-4
PGB100638	3/8"	100	0-6
PGB101038	3/8"	100	0-10
PGB101238	3/8"	100	0-12
PGB102038	3/8"	100	0-20

## Flange Type Pressure Gauges, Centre Back Connection



### BSPT Brass Connection

0021	Thread	Gauge Diameter mm	Pressure Range PSI	Pressure Range Bar
2018-1830	1/4"	50	0-160	0-10
2018-1848	1/4"	50	0-200	0-12

Tech Sheet 20587

## Panel Mount, Stainless Steel Case, Centre Back Connection



### BSPT

0021	Thread	Gauge Diameter mm	Pressure Range PSI	Pressure Range Bar
G50-12PM	1/8"	50	0-200	0-12

Tech Sheet 20588

## Panel Mount Gauge, Centre Back Connection



### BSPT

0021	Thread	Gauge Diameter mm	Pressure Range Bar
56144010	1/8"	40	0-10
56145010	1/8"	50	0-10

Tech Sheet 20386

## Panel Mount, Centre Back Connection



### BPST

0236	Thread	Gauge Diameter mm	Pressure Range Bar	Pressure Range PSI
GCPM402	1/8"	40	0-2	0-30
GCPM404	1/8"	40	0-4	0-60
GCPM407	1/8"	40	0-6	0-100
GCPM4010	1/8"	40	0-11	0-160
GCPM4014	1/8"	40	0-14	0-200
GCPM4020	1/8"	40	0-20	0-300
GCPM502	1/8"	50	0-2	0-30
GCPM504	1/8"	50	0-4	0-60
GCPM507	1/8"	50	0-6	0-100
GCPM5010	1/8"	50	0-11	0-160
GCPM5014	1/8"	50	0-14	0-200

## Panel Mounted Gauge, U Clamp, Back Entry



### BSPB

0237	Thread	Gauge Diameter mm	Pressure Range Bar
VGBU040118	1/8"	40	-1-0
PGBU040418	1/8"	40	0-4
VGBU060114	1/4"	63	-1-0
PGBU061014	1/4"	63	0-10

## Panel Mounted Gauge, Back Entry



### BSPB

0237	Thread	Gauge Diameter mm	Pressure Range Bar
VGBP040118	1/8"	40	-1-0
PGBP040418	1/8"	40	0-4
PGBP040618	1/8"	40	0-6
PGBP041018	1/8"	40	0-10
PGBP041218	1/8"	40	0-12
VGBP060114	1/4"	63	-1-0
PGBP060414	1/4"	63	0-4
PGBP060614	1/4"	63	0-6
PGBP061014	1/4"	63	0-10
PGBP061214	1/4"	63	0-12

## Vacuum Gauges, Panel Mount, Back Connection



### BSPT

0236	Male Thread	Gauge Diameter mm	Max Pressure Bar
GCVPM40/02	1/8"	40	-1
GCVPM50/02	1/8"	50	-1

# DRY GAUGES



## Capsule Gauges, Bottom Connection

1 Millibar = 0.001 bar



### Millibar Scale, BSPT

0021	Thread	Gauge Diameter mm	Pressure Range Millibar
CG63-100B	1/4"	63	0-100
CG63-250B	1/4"	63	0-250
CG63-400B	1/4"	63	0-400
CG63-600B	1/4"	63	0-600

Tech Sheet 20586

## Welding Gauges, Oxygen, Bottom Connection



### BSPP

0021	Thread	Gauge Diameter mm	Pressure Range Bar	Pressure Range PSI
OG50-050	1/4"	50	0-5	0-80
OG50-010	1/4"	50	0-10	0-160

Tech Sheet 20590

## Welding Gauges, Acetylene, Bottom Connection



### BSPP

0021	Thread	Gauge Diameter mm	Pressure Range Bar	Pressure Range PSI
AG50-0015	1/4"	50	0-1.5	0-30

Tech Sheet 20592

## All Stainless Steel Dry Gauges, Bottom Connection



### 63mm Diameter, 1/4" BSPP

0021	Pressure Range PSI	Pressure Range Bar
SSG63-001B	0-15	0-1
SSG63-004B	0-60	0-4
SSG63-012B	0-200	0-12
SSG63-025B	0-400	0-25
SSG63-060B	0-1000	0-60
SSG63-200B	0-3000	0-200
SSG63-400B	0-6000	0-400

Tech Sheet 20589

## All Stainless Steel Dry Gauges, Centre Back Connection



### 63mm Diameter, 1/4" BSPP

0021	Pressure Range PSI	Pressure Range Bar
2038-8484	0-200	0-12
2038-8492	0-300	0-20
2038-8526	0-4000	0-250

Tech Sheet 20591

## Vacuum Gauges, Centre Back Connection



### BSPT, ABS Case

0021	Thread	Gauge Diameter mm	Max Pressure Hg	Max Pressure Bar
VG40-01R	1/8"	40	-30	-1
VG50-01R	1/8"	50	-30	-1
VG50-01T	1/4"	50	-30	-1
VG63-01T	1/4"	63	-30	-1
VG100-01T	3/8"	100	-30	-1

Tech Sheet 20583

### Stainless Steel

0236	Thread	Gauge Diameter mm	Max Pressure Bar
GCV63/04D	1/4" BSPT	63	-1
GCV100/06D	3/8" BSPT	100	-1

## Vacuum Gauges, Bottom Connection



### BSPT, ABS Case

0021	Thread	Gauge Diameter mm	Max Pressure Hg	Max Pressure Bar
VG40-01B	1/8"	40	-30	-1
VG50-01B	1/8"	50	-30	-1
VG50-01C	1/4"	50	-30	-1
VG63-01C	1/4"	63	-30	-1
VG100-01D	3/8"	100	-30	-1

Tech Sheet 20585

### Stainless Steel

0236	Thread	Gauge Diameter mm	Max Pressure Bar
GBV63/04D	1/4" BSPT	63	-1
GBV100/06D	3/8" BSPT	100	-1

# DRY GAUGES



## ABS Case, Centre Back Connection

Accuracy:  
40mm and 50mm diameter: +/- 2.5%



### BSPT

0056	Thread	Gauge Diameter mm	Max Pressure PSI	Max Pressure Bar
WG40-18R-1	1/8"	40	15	1
WG40-18R-2.5	1/8"	40	40	2.5
WG40-18R-4	1/8"	40	60	4
WG40-18R-6	1/8"	40	90	6
WG40-18R-10	1/8"	40	160	10
WG40-18R-16	1/8"	40	230	16
WG40-18R-25	1/8"	40	400	25
WG50-18R-1	1/8"	50	15	1
WG50-18R-2.5	1/8"	50	40	2.5
WG50-18R-4	1/8"	50	60	4
WG50-18R-6	1/8"	50	90	6
WG50-18R-10	1/8"	50	160	10
WG50-18R-16	1/8"	50	230	16
WG50-18R-25	1/8"	50	400	25

Tech Sheet 10524

## Flush Panel Mount, Centre Back Connection



### BSPP

0056	Thread	Gauge Diameter mm	Max Pressure Bar
WG63-14FPM-1BAR	1/4"	63	1
WG63-14FPM-2BAR	1/4"	63	2
WG63-14FPM-4BAR	1/4"	63	4
WG63-14FPM-7BAR	1/4"	63	7
WG63-14FPM-11BAR	1/4"	63	11
WG63-14FPM-14BAR	1/4"	63	14
WG63-14FPM-20BAR	1/4"	63	20
WG63-14FPM-28BAR	1/4"	63	28
WG63-14FPM-40BAR	1/4"	63	40

## Panel Mount Gauge Bracket



### Bracket

0056	To Suit
WGB-63	63mm Rear
WGB-100	100mm Rear

## ABS Case, Bottom Connection

Accuracy:  
40mm and 50mm diameter: +/- 2.5%  
63mm diameter: +/- 1.6%



### BSPP

0056	Thread	Gauge Diameter mm	Max Pressure Bar
WG40-18B-1BAR	1/8"	40	1
WG40-18B-2BAR	1/8"	40	2
WG40-18B-14BAR	1/8"	40	14
WG50-18B-4BAR	1/8"	50	4
WG50-18B-7BAR	1/8"	50	7
WG50-18B-11BAR	1/8"	50	11
WG50-18B-14BAR	1/8"	50	14
WG50-18B-20BAR	1/8"	50	20
WG50-18B-40BAR	1/8"	50	40
WG50-18B-70BAR	1/8"	50	70
WG50-18B-200BAR	1/8"	50	200
WG63-14B-1BAR	1/4"	63	1
WG63-14B-2BAR	1/4"	63	2
WG63-14B-4BAR	1/4"	63	4
WG63-14B-7BAR	1/4"	63	7
WG63-14B-11BAR	1/4"	63	11
WG63-14B-14BAR	1/4"	63	14
WG63-14B-20BAR	1/4"	63	20
WG63-14B-28BAR	1/4"	63	28
WG63-14B-40BAR	1/4"	63	40
WG63-14B-70BAR	1/4"	63	70
WG63-14B-140BAR	1/4"	63	140
WG63-14B-400BAR	1/4"	63	400

Tech Sheet 10523

Accuracy:  
100mm diameter: +/- 1.0%



### BSPP

0056	Thread	Gauge Diameter mm	Max Pressure Bar
WG100-38B-1BAR	3/8"	100	1
WG100-38B-2BAR	3/8"	100	2
WG100-38B-4BAR	3/8"	100	4
WG100-38B-7BAR	3/8"	100	7
WG100-38B-11BAR	3/8"	100	11
WG100-38B-14BAR	3/8"	100	14
WG100-38B-20BAR	3/8"	100	20
WG100-38B-28BAR	3/8"	100	28
WG100-38B-40BAR	3/8"	100	40

Tech Sheet 10523



## GLYCERINE GAUGES &amp; ACCESSORIES



### Stainless Steel Case, Bottom Connection

stainless  
steel



#### BSPT

0021	Thread	Gauge Diameter mm	Pressure Range PSI	Pressure Range Bar
G63-001BG	1/4"	63	0-15	0-1
G63-002BG	1/4"	63	0-30	0-2
G63-004BG	1/4"	63	0-60	0-4
G63-006BG	1/4"	63	0-100	0-6
G63-012BG	1/4"	63	0-200	0-12
G63-020BG	1/4"	63	0-300	0-20
G63-025BG	1/4"	63	0-400	0-25
G63-040BG	1/4"	63	0-600	0-40
G63-060BG	1/4"	63	0-1000	0-60
G63-120BG	1/4"	63	0-2000	0-120
G63-200BG	1/4"	63	0-3000	0-200
G63-250BG	1/4"	63	0-4000	0-250
G63-400BG	1/4"	63	0-6000	0-400
G63-600BG	1/4"	63	0-9000	0-600
VG63-01BG	1/4"	63	-30" Hg	-1 bar

Tech Sheet 20593

stainless  
steel



#### BSPP

0021	Thread	Gauge Diameter mm	Pressure Range PSI	Pressure Range Bar
PG63-001BG	1/4"	63	0-15	0-1
PG63-002BG	1/4"	63	0-30	0-2
PG63-004BG	1/4"	63	0-60	0-4
PG63-006BG	1/4"	63	0-100	0-6
PG63-012BG	1/4"	63	0-200	0-12
PG63-014BG	1/4"	63	0-200	0-14
PG63-020BG	1/4"	63	0-300	0-20
PG63-025BG	1/4"	63	0-400	0-25
PG63-040BG	1/4"	63	0-600	0-40
PG63-060BG	1/4"	63	0-1000	0-60
PG63-120BG	1/4"	63	0-2000	0-120
PG63-200BG	1/4"	63	0-3000	0-200
PG63-250BG	1/4"	63	0-4000	0-250
PG63-400BG	1/4"	63	0-6000	0-400
PG63-600BG	1/4"	63	0-9000	0-600

Tech Sheet 20594

### Stainless Steel Case, Centre Back Connection

See Panel Mount Bracket Options:  
G63-PM & G63-PM-RHOMB

stainless  
steel



#### BSPT

0021	Thread	Gauge Diameter mm	Pressure Range PSI	Pressure Range Bar
G63-001RG	1/4"	63	0-15	0-1
G63-002RG	1/4"	63	0-30	0-2
G63-004RG	1/4"	63	0-60	0-4
G63-006RG	1/4"	63	0-100	0-6
G63-010RG	1/4"	63	0-160	0-10
G63-012RG	1/4"	63	0-200	0-12
G63-020RG	1/4"	63	0-300	0-20
G63-025RG	1/4"	63	0-400	0-25
G63-040RG	1/4"	63	0-600	0-40
G63-060RG	1/4"	63	0-1000	0-60
G63-120RG	1/4"	63	0-2000	0-120
G63-200RG	1/4"	63	0-3000	0-200
G63-250RG	1/4"	63	0-4000	0-250
G63-400RG	1/4"	63	0-6000	0-400
G63-600RG	1/4"	63	0-9000	0-600
VG63-01RG	1/4"	63	-30" Hg	-1 bar

Tech Sheet 20595

See Panel Mount Bracket Options:  
G63-PM & G63-PM-RHOMB

stainless  
steel



#### BSPP

0021	Thread	Gauge Diameter mm	Pressure Range PSI	Pressure Range Bar
PG63-001RG	1/4"	63	0-15	0-1
PG63-002RG	1/4"	63	0-30	0-2
PG63-004RG	1/4"	63	0-60	0-4
PG63-006RG	1/4"	63	0-100	0-6
PG63-012RG	1/4"	63	0-200	0-12
PG63-014RG	1/4"	63	0-200	0-12
PG63-020RG	1/4"	63	0-300	0-20
PG63-025RG	1/4"	63	0-400	0-25
PG63-040RG	1/4"	63	0-600	0-40
PG63-060RG	1/4"	63	0-1000	0-60
PG63-120RG	1/4"	63	0-2000	0-120
PG63-200RG	1/4"	63	0-3000	0-200
PG63-250RG	1/4"	63	0-4000	0-250
PG63-400RG	1/4"	63	0-6000	0-400
PG63-600RG	1/4"	63	0-9000	0-600

Tech Sheet 20596

### Panel Mounting Brackets

stainless  
steel



For G63 & PG63 Centre Back Connection  
below 100 bar

0021  
G63-PM

stainless  
steel



For G63 & PG63 Centre Back Connection  
above 100 bar

0021  
G63-PM-RHOMB

### Gauge Snubbers

Working Pressure:  
20 to 300 bar



#### High Pressure

0234	Male Thread	Female Thread
130.4	1/4"	1/4"
130.3	3/8"	3/8"
130.2	1/2"	1/2"

Tech Sheet 28

Gauge snubbers are a great way of protecting gauges from damage, with sudden impact pressure i.e. when full line pressure is introduced to the gauge damage can occur. With the use of the snubber the gauge will be protected.

Working Pressure:  
0 to 20 bar



#### Low Pressure

0234	Male Thread	Female Thread
131.8	1/8"	1/8"
131.4	1/4"	1/4"
131.3	3/8"	3/8"
131.2	1/2"	1/2"

Tech Sheet 28

### Back Rubber Gauge Protectors



0021	Description
G63-OB	Open
G63-CB	Closed

## All Stainless Steel Gauges, Bottom Connection



BSPP

0021	Thread	Gauge Diameter mm	Pressure Range PSI	Pressure Range Bar
SSG63-001BG	1/4"	63	0-15	0-1
SSG63-004BG	1/4"	63	0-60	0-4
SSG63-012BG	1/4"	63	0-200	0-12
SSG63-025BG	1/4"	63	0-400	0-25
SSG63-060BG	1/4"	63	0-1000	0-60
SSG63-200BG	1/4"	63	0-3000	0-200
SSG63-250BG	1/4"	63	0-4000	0-250
SSG63-400BG	1/4"	63	0-6000	0-400

Tech Sheet 20598

## All Stainless Steel Gauges, Centre Back Connection



BSPP

0021	Thread	Gauge Diameter mm	Pressure Range PSI	Pressure Range Bar
2020-0340	1/4"	50	0-200	0-12
2020-0341	1/4"	50	0-300	0-20
2020-0342	1/4"	50	0-600	0-40
2020-0343	1/4"	50	0-900	0-60
2020-0344	1/4"	50	0-4000	0-250
2038-8534	1/4"	63	0-200	0-12
2038-8567	1/4"	63	0-900	0-60
2038-8575	1/4"	63	0-4000	0-250

Tech Sheet 20600

## Stainless Steel Case, Heavy-duty, Bottom Connection



BSPP

0021	Thread	Gauge Diameter mm	Pressure Range PSI	Pressure Range Bar
HG100-002G	1/2"	100	0-36	0-2.5
HG100-004G	1/2"	100	0-58	0-4
HG100-006G	1/2"	100	0-87	0-6
HG100-010G	1/2"	100	0-145	0-10
HG100-016G	1/2"	100	0-232	0-16
HG100-040G	1/2"	100	0-580	0-40
HG100-100G	1/2"	100	0-1450	0-100
HG100-160G	1/2"	100	0-2320	0-160
HG100-250G	1/2"	100	0-3625	0-250
HG100-400G	1/2"	100	0-5800	0-400



BSPP

0021	Thread	Gauge Diameter mm	Pressure Range PSI	Pressure Range Bar
SHG100-002BG	1/2"	100	0-30	0-2
SHG100-006BG	1/2"	100	0-100	0-6
SHG100-016BG	1/2"	100	0-250	0-16
SHG100-040BG	1/2"	100	0-600	0-40
SHG100-100BG	1/2"	100	0-1500	0-100
SHG100-250BG	1/2"	100	0-4000	0-250
SHG100-600BG	1/2"	100	0-9000	0-600

Tech Sheet 20599



BSPP

0021	Thread	Gauge Diameter mm	Pressure Range PSI	Pressure Range Bar
2038-8435	1/2"	100	0-200	0-12
2038-8443	1/2"	100	0-300	0-20
2038-8450	1/2"	100	0-600	0-40
2038-8476	1/2"	100	0-4000	0-250

Tech Sheet 20601



BSPT

0021	Thread	Gauge Diameter mm	Pressure Range PSI	Pressure Range Bar
HG100-002B	1/2"	100	0-36	0-2.5
HG100-004B	1/2"	100	0-58	0-4
HG100-006B	1/2"	100	0-87	0-6
HG100-010B	1/2"	100	0-145	0-10
HG100-016B	1/2"	100	0-232	0-16
HG100-040B	1/2"	100	0-580	0-40
HG100-100B	1/2"	100	0-1450	0-100
HG100-160B	1/2"	100	0-2320	0-160
HG100-250B	1/2"	100	0-3625	0-250
HG100-400B	1/2"	100	0-5800	0-400

Tech Sheet 20597

## Vacuum Gauges, Centre Back Connection

stainless steel



Stainless Steel

0236	Thread	Gauge Diameter mm	Max Pressure Bar
GCV63/04	1/4" BSPP	63	-1
GCV100/06	3/8" BSPP	100	-1

## Vacuum Gauges, Bottom Connection

stainless steel



Stainless Steel

0236	Thread	Gauge Diameter mm	Max Pressure Bar
GBV63/04	1/4" BSPP	63	-1
GBV100/06	3/8" BSPP	100	-1

# GLYCERINE GAUGES



## Heavy-duty, Bottom Connection

### Accuracy:

63mm diameter: +/- 1.6%  
100mm diameter: +/- 1.0%



### BSPP

0056	Thread	Gauge Diameter mm	Max Pressure Bar	Max Pressure PSI
WG63-14B-1G	1/4"	63	1	15
WG63-14B-1.6G	1/4"	63	1.6	25
WG63-14B-2.5G	1/4"	63	2.5	40
WG63-14B-4G	1/4"	63	4	60
WG63-14B-6G	1/4"	63	6	90
WG63-14B-10G	1/4"	63	10	160
WG63-14B-16G	1/4"	63	16	230
WG63-14B-25G	1/4"	63	25	400
WG63-14B-40G	1/4"	63	40	600
WG63-14B-60G	1/4"	63	60	900
WG63-14B-100G	1/4"	63	100	1600
WG63-14B-160G	1/4"	63	160	2300
WG63-14B-250G	1/4"	63	250	4000
WG63-14B-400G	1/4"	63	400	6000
WG63-14B-600G	1/4"	63	600	9000
WG100-38B-2.5G	3/8"	100	2.5	40
WG100-38B-4G	3/8"	100	4	60
WG100-38B-6G	3/8"	100	6	90
WG100-38B-10G	3/8"	100	10	160
WG100-38B-16G	3/8"	100	16	230
WG100-38B-40G	3/8"	100	40	600
WG100-12B-100G	1/2"	100	100	1600
WG100-12B-160G	1/2"	100	160	2300
WG100-12B-250G	1/2"	100	250	4000
WG100-12B-400G	1/2"	100	400	6000
WG100-12B-600G	1/2"	100	600	9000

Tech Sheet 10525

## Vacuum Gauges, Bottom Connection

### Accuracy:

63mm diameter: +/- 1.6%



### BSPP

0056	Thread	Gauge Diameter mm	Max Pressure Hg	Max Pressure Bar
WG63-14B/-30HG	1/4"	63	-30	-1

Tech Sheet 10525

## Heavy-duty, Centre Back Connection



### BSPP

0056	Thread	Gauge Diameter mm	Max Pressure Bar	Max Pressure PSI
WG63-14R-1G	1/4"	63	1	15
WG63-14R-1.6G	1/4"	63	1.6	25
WG63-14R-2.5G	1/4"	63	2.5	40
WG63-14R-4G	1/4"	63	4	60
WG63-14R-6G	1/4"	63	6	90
WG63-14R-10G	1/4"	63	10	160
WG63-14R-16G	1/4"	63	16	230
WG63-14R-25G	1/4"	63	25	400
WG63-14R-40G	1/4"	63	40	600
WG63-14R-60G	1/4"	63	60	900
WG63-14R-100G	1/4"	63	100	1600
WG63-14R-160G	1/4"	63	160	2300
WG63-14R-250G	1/4"	63	250	3600
WG63-14R-400G	1/4"	63	400	6000
WG63-14R-600G	1/4"	63	600	9000
WG100-38R-2.5G	3/8"	100	2.5	40
WG100-38R-4G	3/8"	100	4	60
WG100-38R-6G	3/8"	100	6	90
WG100-38R-10G	3/8"	100	10	160
WG100-38R-16G	3/8"	100	16	230
WG100-38R-40G	3/8"	100	40	600
WG100-12R-100G	1/2"	100	100	1600
WG100-12R-160G	1/2"	100	160	2300
WG100-12R-250G	1/2"	100	250	4000
WG100-12R-400G	1/2"	100	400	6000
WG100-12R-600G	1/2"	100	600	9000

Tech Sheet 10525

## Vacuum Gauges, Centre Back Connection



### BSPP

0056	Thread	Gauge Diameter mm	Max Pressure Hg	Max Pressure Bar
WG63-14R/-30HG	1/4"	63	-30	-1

Tech Sheet 10525

All pressure gauges can be supplied with a calibration certificate at a nominal charge.  
Please call our Business Development Team for price and delivery.

# TEMPERATURE GAUGES



## Bi-metallic Thermometers, Aluminium Case, Centre Back Connection

Pressure Rating of Thermowell:  
6 bar max



### BSPP

0056	Thread	Gauge Diameter mm	Temperature Range °C
WTG63-60	1/2"	63	0-60
WTG63-120	1/2"	63	0-120
WTG63-200	1/2"	63	0-200
WTG100-60	1/2"	100	0-60
WTG100-120	1/2"	100	0-120
WTG100-200	1/2"	100	0-200

Tech Sheet 10526

## Bi-metallic Thermometers, Stainless Steel Case, Centre Back Connection

Pressure Rating of Thermowell:  
25 bar max

stainless steel



### BSPP

0056	Thread	Gauge Diameter mm	Temperature Range °C
WTG63160-60	1/2"	63	0-60
WTG63160-120	1/2"	63	0-120
WTG160-60	1/2"	100	0-60
WTG160-120	1/2"	100	0-120

Tech Sheet 10527

## Refrigeration Gauges, Plastic Case, Bottom Connection



### 1/4" Flare

0056	Thread	Gauge Diameter mm	Temperature Range °C	Temperature Range °C
WG63-716B-1/9	7/16" UNF	63	-1/+9	-1/+9

## Bi-metallic Thermometers

Other temperatures are available.  
Please call our Technical Department for details.

Pressure Rating of Thermowell:  
35 bar max

stainless steel



### Stainless Steel Case, BSPP

0056	Thread	Gauge Diameter mm	Temperature Range °C
WTG100-TE-60	1/2"	100	0-60
WTG100-TE-120	1/2"	100	0-120

Tech Sheet 10527

## GLYCERINE GAUGES

stainless steel



## Bi-metallic Thermometers

Stainless steel case and stainless steel stem, 100mm insertion.

### Applications:

- Machine and plant engineering, piping, industrial heating
- BSPP Male



### Stainless Steel Case, Back Entry, BSPP

0021	Thread	Gauge Diameter mm	Temperature Range °C
2052-8774	1/4"	63	0-60
2052-8782	1/4"	63	0-120
2052-8790	1/4"	63	0-200
2052-8808	1/4"	63	0-300
2052-8816	1/2"	100	0-60
2052-8824	1/2"	100	0-120
2052-8840	1/2"	100	0-200

Stainless steel case and stainless steel stem, 100mm insertion.

### Applications:

- Machine and plant engineering, piping, industrial heating
- BSPP Male



### Stainless Steel Case, Bottom Entry, BSPP

0021	Thread	Gauge Diameter mm	Temperature Range °C
2052-8873	1/4"	63	0-120
2052-8907	1/2"	100	0-60
2052-8915	1/2"	100	0-120
2052-8923	1/2"	100	0-200



### Temperature Gauges, Bottom Connection



#### BSPP

1480	Thread	Gauge Diameter mm	Stem Length	Range
T401A215A	1/2"	100	5cm	-30 to +60°
T401A251A	1/2"	100	5cm	0 to +120°
T401A251C	1/2"	100	10cm	0 to +120°

### Temperature Gauges, Back Connection



#### BSPP

1480	Thread	Gauge Diameter mm	Stem Length	Range
T401F215A	1/2"	100	5cm	-30 to +60°
T401F215C	1/2"	100	10cm	-30 to +60°
T401F251A	1/2"	100	5cm	0 to +120°
T401F251C	1/2"	100	10cm	0 to +120°

### Mild Steel Syphons



#### BSPP

1480	Thread	Type
ACC01582	3/8"	U
ACC01583	1/2"	U
ACC02082	3/8"	Ring
ACC02083	1/2"	Ring

### Brass Gauge Cocks



#### BSPP

1480	Thread	Type
ACC00005	1/4"	F/F
ACC00006	3/8"	F/F
ACC00007	1/2"	F/F
ACC00022	3/8"	M/F

AIR CONTROL  



new  
product

For **JWL Air Boy** Car Tyre Inflators  
 see page 1723

**Digital Flow & Pressure  
Sensor PR03**



See section 4  
page 420

**Plastic Push-in Fittings  
55000 & 56000 Series**



See section 6  
pages 817-820

**Metal Push-in Fittings  
50000, 55000 58000  
& 89000**



See section 6  
pages 852-861

**316 Stainless Steel  
Push-in Fittings**

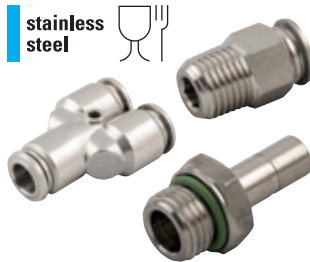

See section 6  
pages 878-879

**Gas Mini Ball Valves,  
Brass**



See section 7  
page 942

**AIGNEP**

**Aluminium Ring  
Main System**

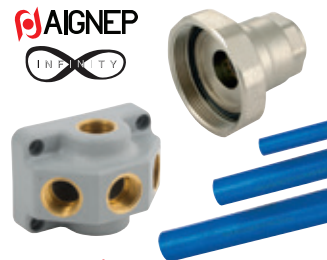

See section 8  
pages 1082-1084

**EXCELLENT SOLUTIONS  
IN FLUID TECHNOLOGY**



# DIGITAL FLOW & PRESSURE SENSOR PR03



## Pressure Switches

The PR03 sensor is available in different sizes, from 1/4" to 3/4", to suit the different flow rates required in the various industrial applications in which it can be used. The largest size allows measurements up to a maximum of 2000 l/min.

The new digital flowmeter offers the following advantage

- **Easily display** the status of the accumulated flow rat .
- **Monitor air flow** in real time.
- **Detect momentary changes** in fluid statu .



### Series PR03

9025	Regulation Range	Thread	Output
PR030103P1	0-100 l/min	1/4"	PNP + Analog Output (1-5V)
PR030203P1	0-200 l/min	1/4"	PNP + Analog Output (1-5V)
PR030505P1	0-500 l/min	1/2"	PNP + Analog Output (1-5V)
PR032007P1	0-2000 l/min	3/4"	PNP + Analog Output (1-5V)
PR030103P2	0-100 l/min	1/4"	PNP + Analog Output (4-20mA)
PR030203P2	0-200 l/min	1/4"	PNP + Analog Output (4-20mA)
PR030505P2	0-500 l/min	1/2"	PNP + Analog Output (4-20mA)
PR032007P2	0-2000 l/min	3/4"	PNP + Analog Output (4-20mA)

Tech Sheet 71761

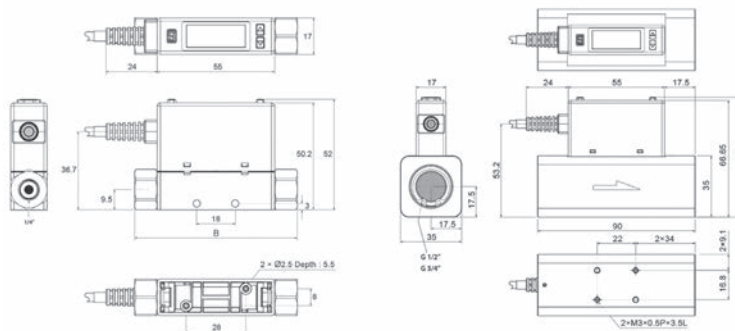

## Digital Flow & Pressure Sensor PR03

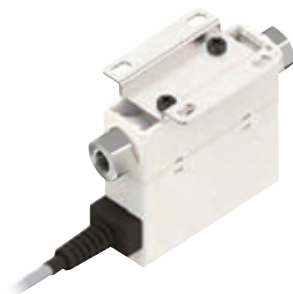
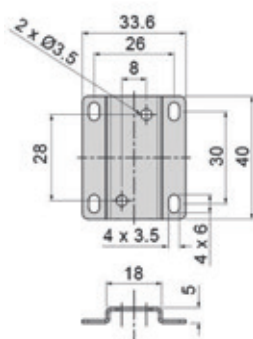

### Mounting Bracket

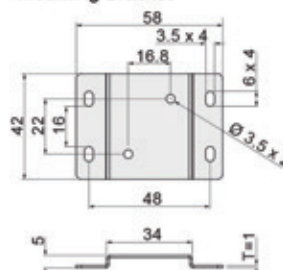

### Mounting Bracket

9025	
PR03B01	For 100-200 l/min

Tech Sheet 71761

### Mounting Bracket

9025	
PR03B05	For 500 l/min
PR03B20	For 2000 l/min

Tech Sheet 71761

# TEMPERATURE SWITCHES



## TBF Series, Push-on Terminal DIN 46248 Normally Closed

° Maximum Working Temperature:  
+125°C

° Maximum Static Pressure:  
200 bar

Economic range  
Material: Brass



### Fixed Set Point, 3/8" BSPP Male

9025	Set Temperature °C
TBF-EV025-C38	25
TBF-EV035-C38	35
TBF-EV045-C38	45
TBF-EV050-C38	50
TBF-EV055-C38	55
TBF-EV060-C38	60
TBF-EV065-C38	65
TBF-EV070-C38	70
TBF-EV075-C38	75
TBF-EV080-C38	80
TBF-EV085-C38	85
TBF-EV090-C38	90
TBF-EV095-C38	95
TBF-EV100-C38	100
TBF-EV105-C38	105
TBF-EV110-C38	110
TBF-EV125-C38	125

Tech Sheet 68798

### Fixed Set Point, 1/2" BSPP Male

9025	Set Temperature °C
TBF-EV025-C12	25
TBF-EV035-C12	35
TBF-EV045-C12	45
TBF-EV050-C12	50
TBF-EV055-C12	55
TBF-EV060-C12	60
TBF-EV065-C12	65
TBF-EV070-C12	70
TBF-EV075-C12	75
TBF-EV080-C12	80
TBF-EV085-C12	85
TBF-EV090-C12	90
TBF-EV095-C12	95
TBF-EV100-C12	100
TBF-EV105-C12	105
TBF-EV110-C12	110
TBF-EV125-C12	125

Tech Sheet 68798

## EBC Series, PG 09 DIN 43650 Connector SPDT IP65

° Maximum Working Temperature:  
+80°C

° Maximum Static Pressure:  
200 bar

Material: Brass



### Fixed Set Point, 1/2" BSPP Male

9025	Set Temperature °C
EBC50C	50
EBC60C	60
EBC70C	70

Tech Sheet 110835

### Fixed Set Point, 3/8" BSPP Male

9025	Set Temperature °C
EBC50B	50
EBC60B	60
EBC70B	70

Tech Sheet 110835

## NTB Series, PG 09 DIN 43650 Connector Normally Open IP65

° Maximum Working Temperature:  
+120°C

° Maximum Static Pressure:  
200 bar

Material:  
Anodised aluminium



### Fixed Set Point with 360° Rotating Head, 1/2" BSPP Male

9025	Set Temperature °C
NTB25CA	25
NTB31CA	31
NTB38CA	38
NTB47CA	47
NTB60CA	60
NTB70CA	70
NTB80CA	80
NTB90CA	90
NTB100CA	100
NTB105CA	105

Tech Sheet 68797

### Fixed Set Point with 360° Rotating Head, 3/8" BSPP Male

9025	Set Temperature °C
NTB25BA	25
NTB31BA	31
NTB38BA	38
NTB47BA	47
NTB60BA	60
NTB70BA	70
NTB80BA	80
NTB90BA	90
NTB100BA	100
NTB105BA	105

Tech Sheet 68797



# PRESSURE TRANSDUCERS

Material: AISI 316

 Working Temperature:  
-25°C to +100°C

stainless  
steel



## PG 09 DIN 43650 Connector IP65

### 0-10V Output, 1/4" BSPP Male

9025	Pressure Range Bar	Max Pressure Bar
PTE1GA-VMDMR14	-1 to 4	4
PTE2GA-VMDMR14	0-2	4
PTE4GA-VMDMR14	-1 to 9	10
PTE5GA-VMDMR14	0-5	10
PTE10GA-VMDMR14	0-10	15
PTE20GA-VMDMR14	0-20	35
PTE50GA-VMDMR14	0-50	100
PTE100GA-VMDMR14	0-100	150
PTE200GA-VMDMR14	0-200	300
PTE400GA-VMDMR14	0-400	500

Tech Sheet 110836

### 4-20mA Output, 1/4" BSPP Male

9025	Pressure Range Bar	Max Pressure Bar
PTE1GA-IMDMR14	-1 to 4	4
PTE2GA-IMDMR14	0-2	4
PTE4GA-IMDMR14	-1 to 9	10
PTE5GA-IMDMR14	0-5	10
PTE10GA-IMDMR14	0-10	15
PTE20GA-IMDMR14	0-20	35
PTE50GA-IMDMR14	0-50	100
PTE100GA-IMDMR14	0-100	150
PTE200GA-IMDMR14	0-200	300
PTE400GA-IMDMR14	0-400	500

Tech Sheet 110836

## M12 x 1.5 Pole Male Connector IP67

### 0-10V Output, 1/4" BSPP Male

9025	Pressure Range Bar	Max Pressure Bar
PTE1GA-VMR14	-1 to 4	4
PTE2GA-VMR14	0-2	4
PTE4GA-VMR14	-1 to 9	10
PTE5GA-VMR14	0-5	10
PTE10GA-VMR14	0-10	15
PTE20GA-VMR14	0-20	35
PTE50GA-VMR14	0-50	100
PTE100GA-VMR14	0-100	150
PTE200GA-VMR14	0-200	300
PTE400GA-VMR14	0-400	500

Tech Sheet 110836

### 4-20mA Output, 1/4" BSPP Male

9025	Pressure Range Bar	Max Pressure Bar
PTE1GA-IMR14	-1 to 4	4
PTE2GA-IMR14	0-2	4
PTE4GA-IMR14	-1 to 9	10
PTE5GA-IMR14	0-5	10
PTE10GA-IMR14	0-10	15
PTE20GA-IMR14	0-20	35
PTE50GA-IMR14	0-50	100
PTE100GA-IMR14	0-100	150
PTE200GA-IMR14	0-200	300
PTE400GA-IMR14	0-400	500

Tech Sheet 110836

**FT** PRO

For **Wired Plugs**  
see page **1043**



# ADJUSTABLE PRESSURE SWITCHES



## PMN Series, Normally Closed, DIN 462488

Seal: Nitrile

° Working Temperature:  
-5°C to +60°C



Push-on 6.3 x 0.8,  
1/4" BSPT Male, Brass

9025	Pressure Range Bar	Max Pressure Bar
PMN1C-BN14K	0.1-1	300
PMN2C-BN14K	0.15-2	300
PMN5C-BN14K	1-5	300
PMN10C-BN14K	2-10	300
PMN20C-BN14K	10-20	300
PMN50C-BN14K	20-50	300
PMN80C-BN14K	50-80	300

Tech Sheet 68789

Push-on 6.3 x 0.8, 1/4" BSPT Male,  
Zinc Plated Steel

9025	Pressure Range Bar	Max Pressure Bar
PMN150C-FN14K	50-150	300
PMN250C-FN14K	100-250	600
PMN300C-FN14K	50-300	600

Tech Sheet 68789

## PMN Series, Normally Open

Seal: Nitrile

° Working Temperature:  
-5°C to +60°C



Push-on 6.3 x 0.8,  
1/4" BSPT Male, Brass

9025	Pressure Range Bar	Max Pressure Bar
PMN1A-BN14K	0.1-1	300
PMN5A-BN14K	1-5	600
PMN2A-BN14K	0.15-2	300
PMN10A-BN14K	2-10	300
PMN50A-BN14K	20-50	300
PMN80A-BN14K	50-80	300

Tech Sheet 68789

Push-on 6.3 x 0.8, 1/4" BSPT Male,  
Zinc Plated Steel

9025	Pressure Range Bar	Max Pressure Bar
PMN150A-FN14K	50-150	300
PMN250A-FN14K	100-250	600
PMN300A-FN14K	50-300	600

Tech Sheet 68789

## PMC Series, PG 09 DIN 43650, SPDT Contacts

Seal: Nitrile

° Working Temperature:  
-5°C to +90°C



1/8" BSPT Male, Anodised Aluminium

9025	Pressure Range Bar	Max Pressure Bar
PMC2	0.15-2	30
PMC5	0.2-5	60
PMC10	0.5-10	100
PMC25	10-25	100
PMC80	25-80	150

Tech Sheet 68791

## PPC Series, PG 90 DIN 43650, SPDT Contacts

Seal: Nitrile

° Working Temperature:  
-5°C to +90°C

Maximum Static Pressure: 600 bar



1/4" BSPT Male, Anodised Aluminium

9025	Pressure Range Bar
PPC150	30-150
PPC300	150-300

Tech Sheet 68791

## PPCF Series, PG 09 DIN 43650, SPDT Contacts

Seal: Nitrile

° Working Temperature:  
-5°C to +90°C

Maximum Static Pressure: 600 bar



1/4" BSPT Female, Anodised Aluminium

9025	Pressure Range Bar
PPCF150	30-150
PPCF300	150-300

Tech Sheet 68791

## PSK Series, PG 09 DIN 43650 with Graduated Knobs

Seal: Nitrile

° Working Temperature:  
-5°C to +90°C



1/4" BSPP Female, Yellow Anodised Aluminium

9025	Pressure Range Bar	Max Pressure Bar
PSK10	1-10	30
PSK100	10-100	300
PSK360	100-300	600

Tech Sheet 38793

# PRESSURE SWITCHES



## High Temperature MS Series, PG 09 DIN 43650, SPDT IP65

**Material:** Brass  
**Seal:** High temperature nitrile

**Working Temperature:**  
-25°C to +140°C

**Maximum Static Pressure:**  
300 bar



### Push-on 6.3 x 0.8, 1/4" BSPT Male

9025	Pressure Range Bar
MS2SC-BNT14K	0.2-2
MS10SC-BNT14K	1-10
MS50SC-BNT14K	10-50
MS100SC-BNT14K	10-100

Tech Sheet 110833

## High Temperature PS Series, PG 09 DIN 43650, SPDT IP65

**Material:** Steel  
**Seal:** High temperature nitrile

**Working Temperature:**  
-25°C to +140°C

**Maximum Static Pressure:**  
600 bar



### Push-on 6.3 x 0.8, 1/4" BSPT Male

9025	Pressure Range Bar
PS150SC-FNT14K	30-150
PS300SC-FNT14K	50-300

Tech Sheet 110833

## Adjustable Hysteresis PSM Series, PG 09 DIN 43650, SPDT IP65

**Material:** Brass  
Adjustable hysteresis 10% - 30% of set-point

**Working Temperature:**  
-5°C to +90°C

**Maximum Static Pressure:**  
300 bar



### 1/4" BSPT Male

9025	Pressure Range Bar
PSM2-BN14K	0.2-2
PSM5-BN14K	1-5
PSM10-BN14K	1-10
PSM50-BN14K	10-50
PSM100-BN14K	10-100

Tech Sheet 110834

## Adjustable Hysteresis PSP Series, PG 09 DIN 43650, SPDT IP65

**Material:** Zinc plated steel  
Adjustable hysteresis: 10% to 30% of set-point

**Working Temperature:**  
-5°C to +90°C

**Maximum Static Pressure:**  
600 bar



### 1/4" BSPT Male

9025	Pressure Range Bar
PSP150-FN14K	30-150
PSP300-FN14K	50-300

Tech Sheet 110834

You may also be interested in...  
**Adjustable Pressure Switches**  
...see page 423



# VACUUM SWITCHES



## VCN Series, Push-on Terminal DIN 46248, Normally Closed

Material: Brass

Seal: Nitrile

° Working Temperature:  
-5°C to +60°C

Maximum Static Pressure:  
20 bar

1/4" BSPT Male

9025	Pressure Range Bar
VCN2C-BN14K	-0.2 to -0.9
Tech Sheet 38794	



## VCN Series, Push-on Terminal DIN 46248, Normally Open

1/4" BSPT Male, Brass

9025	Pressure Range Bar
VCN2A-BN14K	-0.2 to -0.9
Tech Sheet 38794	

## VMC Series, PG 09 DIN 43650, SPDT IP65

Material: Anodised aluminium

Seal: Nitrile

° Working Temperature:  
-5°C to +90°C

Maximum Static Pressure:  
20 bar

Fixed Hysteresis, 1/8" BSPT Male, Anodised Aluminium

9025	Pressure Range Bar
VMC1N	-0.2 to -0.5
Tech Sheet 38794	



## VSM Series, PG 09 DIN 43650, SPDT IP65

Material: Brass

Seal: Nitrile

° Working Temperature:  
-5°C to +90°C

Maximum Static Pressure: 20 bar

Adjustable Hysteresis, 1/4" BSPP Male, Brass

9025	Pressure Range Bar
VSM1-BNR14	-0.1 to -0.5
VSM2-BNR14	-0.5 to -0.9
Tech Sheet 38794	



## Switch Protection

IP54, Cap 1

9025	To Suit Series
CAP54-1	VCN, VCM, PMN, PMM, PM250



IP54, Cap 10

9025	To Suit Series
CAP54-10	VCN, VCM, PMN, PMM



IP54, Cap 12

9025	To Suit Series
CAP54-12	VSM, PSM, PSP



IP54, Cap 16

9025	To Suit Series
CAP54-16	VS, MS, PS



IP65, Cap 3

9025	To Suit Series
CAP65-3	VCM, PMN, PMM, PM250



IP65, Cap 13

9025	To Suit Series
CAP65-13	VS, MS, PS



IP67, Cap M12

9025	To Suit Series
CAP67-M12	VSM, NMC, MS, PS, PSM, PSP, PMC, PPC, PPCF, PMC, PPC, PPL, PSK, MPS





New:  
cylinder sensor SDBT-SMX

# The first self-learning sensor

**FESTO**

The cylinder sensor detects the piston and automatically learns the switching point during commissioning.



Automatically set without any hassle



Just one type for all switching outputs

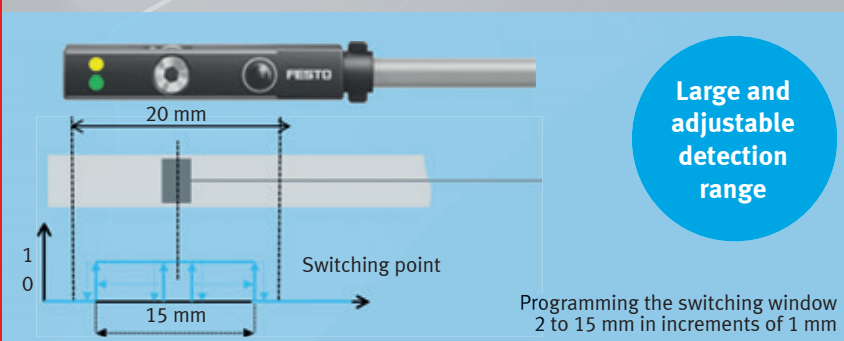

Large and adjustable detection range

Programming the switching window 2 to 15 mm in increments of 1 mm

## The benefits of SDBT-SMX:

### Auto teach-in

The switching point is taught in automatically, so there no longer is a need for precision adjustment.

- Fit, connect - ready!
- Several cylinders at the same time

### Touch button

Programming button for the switching functions NPN/PNP, NO/NC and the switching window.

- Just one type for all switching functions

### Programmable switching window



Setting the switching signal between 2 and 15 mm, for example for early detection of high speeds.

- Flexible position detection

# SFAB SERIES, FLOW SENSORS

**FESTO**

## Airflow Sensor

-  **Ambient Temperature:**
    - 0°C to +50°C
  -  **Working Pressure:**
    - 0 to 10 bar
- Freely selectable pulse output for consumption measurement
  - Analogue filter for setting the rise time
  - Digital filter for smoothing the display values



### 4-20mA, H Rail Mounted Push-in with M12 x 1, 5 Pin Plug

0010	OD mm	Maximum LPM	Manufacturer's Code
565401	10	600	SFAB-600U-HQ10-2SA-M12
565405	10	1000	SFAB-1000U-HQ10-2SA-M12
Tech Sheet 71588			



### 0-10V, H Rail Mounted Push-in with M12 x 1, 5 Pin Plug

0010	OD mm	Maximum LPM	Manufacturer's Code
565402	10	600	SFAB-600U-HQ10-2SV-M12
565406	10	1000	SFAB-1000U-HQ10-2SV-M12
Tech Sheet 71589			

# SFAM SERIES, FLOW SENSORS

**FESTO**

## Airflow Sensor

-  **Ambient Temperature:**
    - 0°C to +50°C
  -  **Working Pressure:**
    - 0 to 16 bar
- Freely selectable pulse output for consumption measurement
  - Analogue filter for setting the rise time
  - Digital filter for smoothing the display values



### 4-20mA, Manifold Assembly

0010	LPM	Manufacturer's Code
564930	1000	SFAM-62-1000L-M-2SA-M12
564934	3000	SFAM-62-3000L-M-2SA-M12
564938	5000	SFAM-62-5000L-M-2SA-M12
573346	5000	SFAM-90-5000L-M-2SA-M12
573348	10000	SFAM-90-10000L-M-2SA-M12
573350	15000	SFAM-90-15000L-M-2SA-M12
Tech Sheet 71590		

### 0-10V, Manifold Assembly

0010	LPM	Manufacturer's Code
564932	1000	SFAM-62-1000L-M-2SV-M12
564936	3000	SFAM-62-3000L-M-2SV-M12
564940	5000	SFAM-62-5000L-M-2SV-M12
573347	5000	SFAM-90-5000L-M-2SV-M12
573349	10000	SFAM-90-10000L-M-2SV-M12
573351	15000	SFAM-90-15000L-M-2SV-M12
Tech Sheet 71591		

# PRESSURE SENSORS

## SPAN Series with Display

- For network monitoring, regulator monitoring, leak test and object detection
- For monitoring compressed air and non corrosive gases
- Relative measurement method based on a piezo-resistive measuring cell
- Serial communication integrated using IO-Link® 1.1
- Compact design
- High-contrast, blue backlit display



 **Ambient Temperature:**  
0°C to +50°C

### Male Thread, BSPP with PNP or NPN Output

0009	Thread	Pressure Range Bar	Manufacturer's Code
8035544	1/8"	0 to 10	SPAN-P10R-G18M-PN-PN-L1
Tech Sheet 70713			

### Male Thread, BSPT with PNP or NPN Output

0009	Thread	Pressure Range Bar	Manufacturer's Code
8035547	1/8"	0 to 10	SPAN-P10R-R18M-PN-PN-L1
Tech Sheet 70715			

### Male Thread, BSPP with PNP, NPN or IO-Link Output

0009	Thread	Pressure Range Bar	Manufacturer's Code
8035533	1/8"	0 to 10	SPAN-P10R-G18M-PNLK-PNVBA-L1
Tech Sheet 70714			

### Male Thread, BSPT with PNP, NPN or IO-Link Output

0009	Thread	Pressure Range Bar	Manufacturer's Code
8035536	1/8"	0 to 10	SPAN-P10R-R18M-PNLK-PNVBA-L1
Tech Sheet 70716			



### Female Thread, Metric & BSPP with PNP, NPN or IO-Link Output

0009	Thread	Pressure Range Bar	Manufacturer's Code
8035539	M5	0 to 10	SPAN-P10R-M5F-PNLK-PNVBA-L1
Tech Sheet 70712			

### Female Thread, Metric & BSPP with PNP or NPN Output

0009	Thread	Pressure Range Bar	Manufacturer's Code
8035550	M5	0 to 10	SPAN-P10R-M5F-PN-PN-L1
Tech Sheet 70711			

### 4mm Push-in Connector with PNP, NPN or IO-Link Output

0009	Pressure Range Bar	Manufacturer's Code
8035541	0 to 10	SPAN-P10R-Q4-PNLK-PNVBA-L1
Tech Sheet 70718		

### 4mm Push-in Connector with PNP or NPN Output

0009	Pressure Range Bar	Manufacturer's Code
8035552	0 to 10	SPAN-P10R-Q4-PN-PN-L1
Tech Sheet 70717		

# FESTO



## Accessories

### Mounting Brackets, PU

0010	Manufacturer's Code
8003354	SAMH-PU-A
Tech Sheet 71593	

Accessory to: SPAN



### Wall Mounting Brackets, PN

0009	Manufacturer's Code
8035563	SAMH-PN-W
Tech Sheet 71594	

Accessory to: SPAN, SCDN



## NEBS Series, Connecting Cables For Sensors



### 4 Pin PCB Plug Connector x 4 Wire Open End with Label Holder

0009	Cable Length Metres	Connection Angle	Manufacturer's Code
572576	2.5	Straight	NEBS-L1G4-K-2.5-LE4
572577	5	Straight	NEBS-L1G4-K-5-LE4
Tech Sheet 70286			

Accessories to: SPAN, SFAH, SCDN sensors

# PRESSURE SWITCHES



## Electro-Mechanical Pressure Switch

- Gold-plated contacts
- High cycle life
- Vibration resistant to 15g

Working Temperature:  
-10°C to +85°C



### 18D Pneumatic

0036	Thread	Switching Pressure Difference
0880600000000000	1/4"	1,00 to 5,00 bar
0880160000000000	1/4"	0.15 to 0.18 bar
0880260000000000	1/4"	0.2 to 0.35 bar
0880460000000000	1/4"	0.40 to 1,20

Tech Sheet 71726

## Electronic Pressure Sensor Digital

- Compact, robust and light weight
- Pressure display colour change configurable
- High overpressure and vacuum resistance
- Housing: Stainless steel (1.4404 / 316L)

Working Temperature:  
0°C to +70°C



### 54D Pneumatic

0036	Thread	Working Pressure
54D-V101G-DD0-AA	1/8"	-1 to 1
54D-V110G-DD0-AA	1/8"	-1 to 10
54D-P016G-DD0-AA	1/8"	0 to 16
54D-V101G-DA1-AA	1/8"	-1 to 1
54D-V110G-DA1-AA	1/8"	-1 to 10
54D-P016G-DA1-AA	1/8"	0 to 16
0523449000000000	1.5m Cable, 4-pin	-
0523447000000000	5m Cable, 4-pin	-

Tech Sheet 71728

## Electro-Mechanical Pressure Switch, Digital

- Multicolour 4-digit display
- Upper body can be rotated 345° relative to the process connection for easy alignment of the display
- Suitable for harsh industrial and process control environments
- Housing: Stainless steel (1.4404 / 316L)

Working Temperature:  
-25°C to +80°C



### 34D Pneumatic/Hydraulic/Allfluid

0036	Thread	Working Pressure
34D-V101G-DD1-AA	1/4	-1 to 1
34D-V110G-DD1-AA	1/4	-1 to 10
34D-P016G-DD1-AA	1/4	0 to 16
34D-V101G-DA1-AA	1/4	-1 to 1
34D-V110G-DA1-AA	1/4	-1 to 10
34D-P016G-DA1-AA	1/4	0 to 16
34D-BRKT-ANGLED	Wall mounting kit	-
0523058000000000	1.5m Cable, 4-pin	-
0523053000000000	5m Cable, 4-pin	-

Tech Sheet 71727

## Electronic Pressure Switch with IO-Link

- IO-Link output option
- Set points parameters set via software
- Robust pressure sensor
- Excellent long life
- Suitable for harsh industrial environments
- High over pressure resistance

Working Temperature:  
-40°C to +90°C



### 60D Pneumatic/Hydraulic/Allfluid

0036	Thread	Working Pressure
60D-V110G-DD1-AA	1/4	-1 to 1
60D-P100G-DD1-AA	1/4	0 to 100

Tech Sheet 71729

## Electronic Pressure Sensor

- Robust pressure sensor
- Excellent long life
- Suitable for harsh industrial environments
- High over pressure resistance

Working Temperature:  
-40°C to +90°C



### 60S Pneumatic/Hydraulic/Allfluid

0036	Thread	Working Pressure
60S-V110G-A42-AA	1/4	-1 to 1
60S-P010G-A42-AA	1/4	-1 to 10
60S-P016G-A42-AA	1/4	0 to 16

Tech Sheet 71730



# PARKER D.H FILTERS & DRAINS AIR, WATER, VACUUM



## Parker D.H Filters & Drains



### Electronic Zero Loss Condensate Drains

0050	Capacity Compressor 1 m <sup>3</sup> /h	Capacity Dryer 1 m <sup>3</sup> /h	Connection
ED3004-G230	2400	480	1 x G1/2"
ED3007-G230	4200	840	2 x G1/2"



### Oil-X Combination Point of Use Filter

0050	Size	L/S	CFM
AC015CBFI	1/2"	13	27



### Combination Replacement Element Kit

0050	Description
015AC	2nd Stage Element



### Replacement Element Kit Oil-X Evolution AA Filters

0050	Range
015AA	015AA
020AA	020AA
025AA	025AA



### Oil-X Evolution Filter Accessories, 1/4" to 3" Models

0050	Filter Model	Description
FXKE1	005-010	Filter Fixing Clamp Kit
FXKE3	025-030	Filter Fixing Clamp Kit
605009902	AC010-AC030	Oil Indicator
EF1	AO/AA GRADE	Replacement Drains



### Oil-X Plus Replacement AO/AA Elements for Oil-X Filters (94-04)

0050	Housing Type	Description
K030AO	0030G	Pre Filter Element
K145AO	0080G	Pre Filter Element
K009AA	0009G	High Efficiency Element
K030AA	0030G	High Efficiency Element
K145AA	0080G	High Efficiency Element

### Oil-X Plus Activated Carbon Elements (94-04)

0050	Housing Type	Description
K006AC	AC-0006G	Activated Carbon Element

### Old Model Oil-X Plus Filter Spares (94-04)

0050	Housing Type	Description
605006520	0006G-0009G	Automatic Drain Kit
605006250	0017G-01045G	Automatic Drain Kit



For Transair Ring Main System  
see page 1063



# KEEP ON CONNECTING



Your Partner for Air & Other Fluids  
Low Pressure Solutions

 legris

 RECTUS



Manufactured in Europe



ENGINEERING YOUR SUCCESS.

# CONDENSATE MANAGEMENT

## Refrigerated Dryers & Filters 600 - 150000 L/min



### Final Filters (0.01 Micron)

0640	CFM	G	DxH mm
HM10	30	3/8"	100x220
HM18	59	1/2"	100x250
HM30	88	3/4"	120x290
HM34	118	3/4"	120x360



### Refrigerated Dryers

0640	Gas	CFM	Bar	G
RD6.A	R134a	21	16	1/2"
RD9.A	R134a	34	16	1/2"
RD12.A	R134a	42	16	1/2"
RD18.A	R134a	64	16	1/2"
RD25.A	R134a	88	14	1"
RD32.A	R134a	113	14	1.1/4"
RD43.A	R407c	152	14	1.1/4"
RD52.A	R407c	184	14	1.1/4"
RD63.A	R407c	222	14	1.1/2"
RD80.A	R407c	283	14	1.1/2"

## Donaldson Membrane Dryers



### Donaldson VarioDry Membrane Dryers

0640	m <sup>3</sup> /h-(CFM) Inlet	m <sup>3</sup> /h-(CFM) Outlet	Connection
SPN0006	6.0 (3.53)	5.5 (3.24)	G 1/4"
SPN0009	9.0 (5.30)	8.1 (4.80)	G 1/4"
SPN0012	12.0 (7.10)	10.8 (6.40)	G 1/4"
SPN0018	18.0 (10.62)	16.2 (9.50)	G 1/2"
SPN0024	24.0 (14.12)	21.6 (12.71)	G 1/2"
SPN0036	36.0 (21.19)	32.4 (19.07)	G 1/2"
SPN0048	48.0 (28.25)	43.2 (25.43)	G 1/2"
SPN0063	63.0 (37.08)	56.7 (33.37)	G 1/2"



For Stainless Steel Tube Fittings  
see pages 165-178

**Installation:** always in combination with a full receiver kit, water drain and safety relief valve. Ensure the compressor never takes in air/solvent mix. This could cause the tank to explode.

The air receiver or tank allows the storage and control of compressed air. A device on most compressors maintains pressure at a predetermined pressure range, allowing the compressor to operate automatically as the air is used, switching on and off accordingly. The air receiver must also be fitted with a safety device to prevent over pressurisation, a means of draining condensate and various outlet sockets. The size of air receiver (usually measured in litres) will normally be proportional to the size or capacity of air compressor fitted.

**Material:** carbon steel

**Finishing:** external RAL 5015 blue paint

**Fluid content:** compressed air and nitrogen (group 2)

All air receivers for the European market are supplied with a declaration of conformity

In compliance with the applicable EU Directives or according to the major international standards:

SPVD 2014/29/UE Directive (ex 2009/105/EC)

PED 2014/68/UE Directive (ex 97/23/EC)

ABS American Bureau of Shipping

DNV Det Norske Veritas

B.V. Bureau Veritas

LRS Lloyd's Register of Naval Ship

GL Germanischer Lloyd

**Available upon request:**

- Internal and external hot dip galvanization
- 16 bar rated
- Alternative port sizes

**Vessel options include:**

- Stainless steel vessels
- Pressurised water vessels
- High pressure vessels
- Vacuum vessels
- Oxygen vessels
- Oversized vessels

**Working Temperature:**

11 bar versions: 10°C to +100°C

12 bar versions: 10°C to +50°C

**Maximum Working Pressure:**

11 bar SPVD 2014/29/UE

12 bar PED 2014/68/UE



Additional carriage charges will apply to this product and will vary dependant on location. This overrides any other carriage agreements. For further details please contact us.



**Ensure the compressor never takes in air/solvent mix. This could cause the tank to explode.**

## Receiver Kits

For illustration purposes only, each kit contains different components based on the specific connections of each air receiver



Each kit to suit vertical air receivers contains a mechanical float condensate drain (50 litre onwards), safety relief valve, ball valve, gauge and connection materials

### To suit Vertical Air Receivers, RAL 5015

0085	To Suit Type	To Suit Litres
AVK-24B	VEC01295	24
AVK-50B	VEC01296	50
AVK-100B	VEC00644	100
AVK-150B	VEC00709	50
AVK-200B	VEC00645	200
AVK-270B	VEC00478	270
AVK-500B	VEC00493	500
AVK-720B	VEC00507	720
AVK-900B	VEC00511	900
AVK-1000B	VEC00518	1000
AVK-1500B	VEC00525	1500
AVK-2000B	VEC00528	2000
AVK-3000B	VEC00535	3000

Each kit to suit horizontal air receivers contains a drain valve, safety relief valve, ball valve, gauge and connection materials

### To suit Horizontal Air Receivers, RAL 5015

0085	To Suit Type	To Suit Litres
AHK-5B	VEC01294	5
AHK-10B	VEC01249	10
AHK-15B	VEC01237	15
AHK-24B	VEC01250	24
AHK-50B	VEC01251	50
AHK-100B	VEC00633	100
AHK-150B	VEC00634	150
AHK-200B	VEC00635	200
AHK-270B	VEC00474	270
AHK-500B	VEC00728	500
AHK-720B	VEC00873	720
AHK-900B	VEC00707	900
AHK-1000B	VEC00515	1000
AHK-1500B	VEC00739	1500
AHK-2000B	VEC00680	2000
AHK-3000B	VEC00534	3000

## Horizontal with Fixing Bracket



### BSPP Ported, RAL 5015

0458	Litres	Max Pressure Bar	Kg
VEC01294	5	11	7
VEC01249	10	11	8
VEC01237	15	11	9
VEC01250	24	11	10
VEC01251	50	11	19
VEC01095	100	11	29
VEC02139	150	11	44
VEC01732	200	11	55
VEC01733	270	11	67
VEC00728	500	11	130
VEC00873*	720	11	178
VEC00707*	900	11	194
VEC00515*	1000	12	210
VEC00739*	1500	12	325
VEC00680*	2000	12	394
VEC00534*	3000	12	605

Tech Sheet 20570

## Vertical with Fixing Bracket



### BSPP Ported, RAL 5015

0458	Litres	Max Pressure Bar	Kg
VEC01295	24	11	10
VEC01296	50	11	19
VEC00644	100	11	29
VEC00709	150	11	44
VEC00645	200	11	55
VEC00478	270	11	67
VEC00493	500	11	115
VEC00511*	900	11	194
VEC00518*	1000	12	210
VEC00525*	1500	12	320
VEC00528*	2000	12	388
VEC00535*	3000	12	594

Tech Sheet 20570



\*Direct delivery, to Mainland UK only, on any air receiver above 500 litres. Please contact your Account Manager.



# AIR RECEIVERS & ACCESSORIES



## Vertical with Fixing Bracket

**Installation:** always in combination with a full receiver kit, water drain and safety relief valve. Ensure the compressor never takes in air/solvent mix. This could cause the tank to explode.

Additional carriage charges will apply to this product and will vary dependant on location. This overrides any other carriage agreements. For further details please contact us.

**Working Temperature:**  
11 bar versions: 10°C to +100°C  
12 bar versions: 10°C to +50°C

**Maximum Working Pressure:**  
11 bar SPVD 2014/29/UE  
12 bar PED 2014/68/UE

**Ensure the compressor never takes in air/solvent mix. This could cause the tank to explode.**



### BSPP Ported, Galvanised

0458	Litres	Max Pressure Bar	Weight Kg
VEC00901	100	11	32
VEC00908	200	11	57
VEC00909	270	11	70
VEC00906	500	11	119
VEC00519	1000	12	214
VEC00529	2000	12	394
VEC00536	3000	12	600

Tech Sheet 60120

## Receiver Kits

For illustration purposes only, each kit contains different components based on the specific connections of each air receiver



Each kit to suit vertical air receivers contains a mechanical float condensate drain (50 litre onwards), safety relief valve, ball valve, gauge and connection materials

### To suit Vertical Air Receivers, Galvanised

0085	To Suit Type	To Suit Litres
AVK-100G	VEC00901	100
AVK-200G	VEC00908	200
AVK-270G	VEC00909	270
AVK-500G	VEC00906	500
AVK-720G	VEC00907	720
AVK-900G	VEC00512	900
AVK-1000G	VEC00519	1000
AVK-2000G	VEC00529	2000
AVK-3000G	VEC00536	3000

## Reservoir Tanks



### 1/2" Inlet/Outlet Reservoir Tanks

0088	Litres	Height mm	Ø mm
7710061	2.5	166	160
7710062	5	175	210
7710063	7	240	210
7710064	12	365	229

Tech Sheet 808

## Long Life Compressor Oil

ISO 46 low carbon formation characteristics. Suitable for screw, reciprocating, axial flow and rotary vane compressors.



0085	Litres
2020-6025	5

Tech Sheet 1382



For M-Press Press Fit Piping System  
see pages 1116-1134



\*Direct delivery, to Mainland UK only, on any air receiver above 500 litres. Please contact your Account Manager.



## No Loss Pneumatic & Electric Drain



### No Loss Pneumatic Condensate Drain 1/2"

0600	Inlet/Outlet BSPP	Pressure (bar)
TVR-20B	1/2" Male/Female	20



### Zero Loss Electric Drain - 106 CFM Capacity

0600	Capacity (CFM)	Thread
TZLD100	106	G1/2"



### Zero Loss Electric Drain - 350 CFM Capacity

0600	Capacity (CFM)	Thread
TZLD300	353 (Compressor)	G1/2"

## Condensate Separators



### Disposable Condensate Separator

0600	Capacity (CFM)
TCS60	60



### Condensate Separator - 100 CFM Capacity

0600	Capacity (CFM)
TCS100	100



### TCS100 Service Kit

0600	Description
TCS100-KIT	Service Kit TCS100



For **Automatic Drain Valves**  
see pages 1024-1025



# SIGHT GLASSES & FLOW INDICATORS

## 200 Series - All Stainless Steel

A low cost, all stainless steel sight flow indicator straight through type.

 **Maximum Working Pressure:**  
10 bar at 200°C

**stainless steel**



**RHODES**

### 233 Model Through Type

0115	Thread	OD mm	Length mm
RHO-FIS-146410-1	1/2" BSPT	15	70

Tech Sheet 10037

A low cost, all stainless steel sight flow indicator fitted with a flap and scale plate to give an indication of the flow rate

 **Maximum Working Pressure:**  
10 bar at 200°C

**stainless steel**



**RHODES**

### 234 Model with Flap & Plate

0115	Thread	OD mm	Length mm
RHO-FIS-146510-1	1/2" BSPT	15	70
RHO-FIS-146510-2	1/2" BSPP	15	70
RHO-FIS-146515-2	3/4" BSPP	20	70

Tech Sheet 10037

## 400 Series - Straight Through Sight Flow Indicator with Spinner/Ball

 **Maximum Working Pressure:**  
16 bar at 100°C

**stainless steel**



**RHODES**

**Stainless Steel with Spinner**

0115	Thread	Min LPH	Max LPH
RHO-FIS-140300-1	1/4" BSPT	30	200
RHO-FIS-140305-1	3/8" BSPT	50	450
RHO-FIS-140305-2	3/8" BSPP	50	450
RHO-FIS-140310-1	1/2" BSPT	60	600
RHO-FIS-140310-2	1/2" BSPP	60	600
RHO-FIS-140315-1	3/4" BSPT	120	1600
RHO-FIS-140320-1	1" BSPT	300	1600

Tech Sheet 10038

## 400 Series - Straight Through Sight Flow Indicator with Spinner/Ball

 **Maximum Working Pressure:**  
7 bar at 100°C

**RHODES**

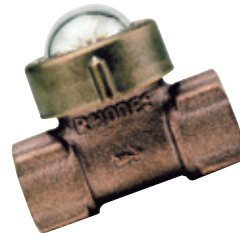

### With Spinner, Gun Metal

0115	Thread	Min LPH	Max LPH
RHO-FIG-170300-1	1/4" BSPT	30	200
RHO-FIG-170300-2	1/4" BSPP	30	200
RHO-FIG-170305-1	3/8" BSPT	50	450
RHO-FIG-170305-2	3/8" BSPP	50	450
RHO-FIG-170310-1	1/2" BSPT	60	600
RHO-FIG-170310-2	1/2" BSPP	60	600
RHO-FIG-170315-1	3/4" BSPT	120	1600
RHO-FIG-170315-2	3/4" BSPP	120	1600
RHO-FIG-170320-1	1" BSPT	300	1600
RHO-FIG-170320-2	1" BSPP	300	1600

Tech Sheet 10038

 **Maximum Working Pressure:**  
7 bar at 100°C

**RHODES**



### With Ball, Gun Metal

0115	Thread	Min LPH	Max LPH
RHO-FIG-176600-1	1/4" BSPT	30	200
RHO-FIG-176600-2	1/4" BSPP	30	200
RHO-FIG-176605-1	3/8" BSPT	50	450
RHO-FIG-176610-1	1/2" BSPT	60	600
RHO-FIG-176610-2	1/2" BSPP	60	600
RHO-FIG-176615-1	3/4" BSPT	120	1600
RHO-FIG-176615-2	3/4" BSPP	120	1600
RHO-FIG-176615-3	3/4" NPT	120	1600
RHO-FIG-176620-1	1" BSPT	300	1600
RHO-FIG-176620-2	1" BSPP	300	1600

Tech Sheet 10038

## Bronze Sight Glass/Indicator

 **Maximum Working Temperature:**  
150°C

**Specification**  
Hardened single glass inspection window.

 **Maximum Working Pressure:**  
16 bar

**FT PRO**



### BSPP

0118	Thread
2021-1330	1/2"
2021-1348	3/4"
2021-1355	1"

Tech Sheet 821

Can't see the product you're looking for? Contact us. More often than not, we can acquire that product.



Are you looking for...  
**a stainless steel flanged PN16 sight glass?**  
...see page 963

# FLOW SWITCHES



## Adjustable IF-E Series, Normally Open, IP65

Working Temperature:  
-10°C to +80°C

Maximum Working Pressure:  
50 bar

Viscosity up to 1 cSt,  
PG 09 DIN 43650, BSPP Female



9025	Thread	LPM
IFE0.5R2.5	1/8"	0.1-2.5
IFE1R3	1/8"	0.3-3
IFE2R9	1/4"	2-9
IFE3R18	3/8"	3-18
IFE5R35	3/4"	6-35
IFE6R60	1"	15-60
IFE4R24	1/2"	3-24

Tech Sheet 110837

## Adjustable IF\_VE Series, Visual, Normally Open, IP65

Working Temperature:  
-10°C to +100°C

Maximum Working Pressure:  
15 bar



Viscosity up to 14.4 cSt, PG 09 DIN 43650, BSPP Female

9025	Thread	LPM
IF1VE1/A-M6	1/4"	0.1-1
IF2VE3/A-M6	1/4"	0.2-3
IF3VE6/A-M6	1/4"	1-6
IF4VE16/A-M6	1/2"	2-16
IF5VE60/A-M6	1"	5-60

Tech Sheet 110832

Viscosity up to 39.8 cSt, PG 09 DIN 43650, BSPP Female

9025	Thread	LPM
IF1VE1/A-M7	1/4"	0.1-1
IF3VE6/A-M7	1/4"	1-6
IF4VE16/A-M7	1/2"	2-16
IF5VE60/A-M7	1"	5-60

Tech Sheet 110832

Viscosity up to 70.4 cSt, PG09 DIN 43650, BSPP Female

9025	Thread	LPM
IF1VE1/A-M8	1/4"	0.1 - 1 LPM
IF2VE3/A-M8	1/4"	0.2 - 3 LPM
IF3VE6/A-M8	1/4"	1 - 6 LPM
IF4VE16/A-M8	1/2"	2 - 16 LPM
IF5VE60/A-M8	1"	5 - 60 LPM

Tech Sheet 110832

## FPL Series, Paddle SPDT IP65

Maximum Working Temperature:  
+120°C



1" BSPP Male, Brass

9025	Nm³/h	Max Pressure Bar
FPL1E	1-2.1	11

Tech Sheet 114

1" BSPP Male, Stainless Steel

9025	Nm³/h	Max Pressure Bar
FPL2E	46.5-94.2	30

Tech Sheet 114



BSPP Female, Brass with T Fitting

9025	Thread	Nm³/h	Max Pressure Bar
FPL1E-12	1/2"	1-2.1	11
FPL1E-34	3/4"	1-2.1	11
FPL1E-1	1"	1-2.1	11
FPL1E-114	1.1/4"	1-2.1	11
FPL1E-112	1.1/2"	1-2.1	11
FPL1E-2	2"	1-2.1	11

Tech Sheet 20003

# FLOW INDICATORS



## CFV Series, Propeller

° Maximum Working Temperature:  
+90°C

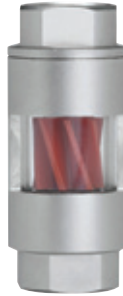

### Viscosity up to 250 cSt, BSPP Female

9025	Thread	LPM
CFV1B-N	1/4"	1-10
CFV2B-N	3/8"	2-20
CFV3B-N	1/2"	3-30
CFV4B-N	3/4"	4-40
CFV5B-N	1"	6-60

Tech Sheet 110829

## IF...V Series, Visual Indicator

° Working Temperature:  
-10°C to +100°C

° Maximum Working Pressure:  
15 bar



### Viscosity up to 14.4 cSt, Female

9025	Thread	LPM
IF1V1/A-M6	1/4"	0.1-1
IF2V3/A-M6	1/4"	0.2-3
IF3V6/A-M6	1/4"	1-6
IF4V16/A-M6	1/2"	2-16
IF5V60/A-M6	1"	5-60

Tech Sheet 110830

### Viscosity up to 39.8 cSt, BSPP Female

9025	Thread	LPM
IF1V1/A-M7	1/4"	0.1-1
IF2V3/A-M7	1/4"	0.2-3
IF3V6/A-M7	1/4"	1-6
IF4V16/A-M7	1/2"	2-16
IF5V60/A-M7	1"	5-60

Tech Sheet 110830

### Viscosity up to 70.4 cSt, BSPP Female

9025	Thread	LPM
IF1V1/A-M8	1/4"	0.1-1
IF2V3/A-M8	1/4"	0.2-3
IF3V6/A-M8	1/4"	1-6
IF4V16/A-M8	1/2"	2-16
IF5V60/A-M8	1"	5-60

Tech Sheet 110830

You may also be interested in...

**Flow Meters**  
...see page 440



# VARIABLE AREA FLOW METERS



## TFM Series, Vertical Type

° Working Temperature:  
0°C to +60°C

Maximum Working Pressure:  
10 bar



### Gas/Air, BSPT Female, Silicone Gasket

9025	Thread	Nm <sup>3</sup> /h
TFM01VG10	1/2"	1-10
TFM02VG16	1/2"	1.6-16
TFM03VG40	1/2"	4-40
TFM04VG60	1"	6-60
TFM05VG160	1"	16-160
TFM06VG250	1"	25-250
TFM07VG350	1"	35-350

Tech Sheet 110831

### Gas/Air, BSPT Male, Silicone Gasket

9025	Thread	Nm <sup>3</sup> /h
TFM08VG250	1.1/2"	25-250
TFM09VG350	1.1/2"	35-350
TFM10VG400	1.1/2"	80-400
TFM11VG500	2"	100-500
TFM12VG600	2"	120-600
TFM13VG850	2"	300-850
TFM14VG1200	2"	400-1200
TFM15VG1400	2"	550-1400

Tech Sheet 110831

### Liquid, BSPT Female, Silicone Gasket

9025	Thread	LPM
TFM01VL4	1/2"	0.5-4
TFM02VL7	1/2"	1-7
TFM03VL18	1/2"	8-18
TFM05VL70	1"	10-70
TFM07VL150	1"	20-150
TFM10VL220	1.1/2"	80-220
TFM11VL300	2"	80-300
TFM12VL360	2"	80-360
TFM13VL450	2"	150-450
TFM14VL550	2"	190-550
TFM15VL750	2"	220-750

Tech Sheet 110831

## FMP Series, Panel Type

° Working Temperature:  
0°C to +60°C

Maximum Working Pressure:  
10 bar



### Gas/Air, BSPT Male, Silicone Gasket

9025	Thread	Nm <sup>3</sup> /h
FMP01VG1	1/2"	0.1-1
FMP02VG6	1/2"	0.6-6
FMP06VG10	1/2"	1-10
FMP07VG16	1/2"	1.6-16
FMP08VG25	1/2"	2.5-25
FMP09VG40	1/2"	4-40
FMP10VG100	1"	10-100
FMP11VG100	1"	20-100
FMP12VG160	1"	16-160
FMP13VG250	1"	25-250
FMP14VG300	1"	30-300
FMP15VG350	1"	35-350

Tech Sheet 110838

### Liquid, BSPT Male, Silicone Gasket

9025	Thread	LPM
FMP03VL100	1/2"	10-100 LPH
FMP04VL160	1/2"	16-160 LPH
FMP06VL4	1/2"	0.5-4
FMP07VL7	1/2"	1-7
FMP08VL11	1/2"	1-11
FMP09VL18	1/2"	2-18
FMP10VL35	1"	5-35
FMP11VL50	1"	10-50
FMP12VL70	1"	10-70
FMP15VL170	1"	10-170

Tech Sheet 110838



# FLOW METERS

## Low Pressure Flow Meters



### Water

0061	Thread	LPM
2018-2929	1/4" Male	0.04-0.4
2018-2937	1/2" Female	0.3-3.75
2018-2938	1/2" Female	1-19
Tech Sheet 2008		

### Air

0061	Thread	SCFM
2040-1626	1/2"	1-15
2040-1634	1/2"	2-20
Tech Sheet 2008		

## Flow Meters



### Standard Water Meters, 3/4" BSPT

0061	Thread	LPM
2018-2838	3/4"	2-15
2018-2853	3/4"	4-35
2018-2887	3/4"	15-65
2018-2903	3/4"	20-100
Tech Sheet 2009		



### Water Meters & Flowalert Signal, 3/4" BSPT

0061	Thread	LPM
2018-2911	3/4"	20-100
Tech Sheet 2009		

## Water & Oil



### Water, BSPP, fm

0061	Thread	LPM	Max Pressure Bar
2018-1947	1/4"	1-7.5	122
2018-1970	3/4"	10-115	183
2039-9432	1"	15-150	183
Tech Sheet 2010			

Note: Other flow rate units available on request



### Oil, BSPP, fm

0061	Thread	LPM	Max Pressure Bar
2039-9119	1/4"	0.2-1.9	122
2039-9184	3/4"	5-38	183
2018-1913	3/4"	10-115	183
2039-9200	1"	10-115	183
2039-9218	1"	19-150	183
Tech Sheet 2010			

# FLOAT LEVEL SWITCHES



° Working Temperature:  
-10°C to +80°C



## Fixed Thermostat, Normally Closed IP65

### Top Entry 100mm, PG 09 DIN 43650 Connection

9025	Actuation Temperature °C
LM1FA100-T40	40
LM1FA100-T50	50
LM1FA100-T60	60
LM1FA100-T70	70
LM1FA100-T80	80

Tech Sheet 110840

### Top Entry 150mm, PG 09 DIN 43650 Connection

9025	Actuation Temperature °C
LM1FA150-T40	40
LM1FA150-T50	50
LM1FA150-T60	60
LM1FA150-T70	70
LM1FA150-T80	80

Tech Sheet 110840

### Top Entry 200mm, PG 09 DIN 43650 Connection

9025	Actuation Temperature °C
LM1FA200-T40	40
LM1FA200-T50	50
LM1FA200-T60	60
LM1FA200-T70	70
LM1FA200-T80	80

Tech Sheet 110840

### Top Entry 250mm, PG 09 DIN 43650 Connection

9025	Actuation Temperature °C
LM1FA250-T40	40
LM1FA250-T50	50
LM1FA250-T60	60
LM1FA250-T70	70
LM1FA250-T80	80

Tech Sheet 110840

### Top Entry 300mm, PG 09 DIN 43650 Connection

9025	Actuation Temperature °C
LM1FA300-T40	40
LM1FA300-T50	50
LM1FA300-T60	60
LM1FA300-T70	70
LM1FA300-T80	80

Tech Sheet 110840

### Top Entry 350mm, PG 09 DIN 43650 Connection

9025	Actuation Temperature °C
LM1FA350-T40	40
LM1FA350-T50	50
LM1FA350-T60	60
LM1FA350-T70	70
LM1FA350-T80	80

Tech Sheet 110840

### Top Entry 400mm, PG 09 DIN 43650 Connection

9025	Actuation Temperature °C
LM1FA400-T40	40
LM1FA400-T50	50
LM1FA400-T60	60
LM1FA400-T70	70
LM1FA400-T80	80

Tech Sheet 110840

### Top Entry 450mm, PG 09 DIN 43650 Connection

9025	Actuation Temperature °C
LM1FA450-T40	40
LM1FA450-T50	50
LM1FA450-T60	60
LM1FA450-T70	70
LM1FA450-T80	80

Tech Sheet 110840

### Top Entry 500mm, PG 09 DIN 43650 Connection

9025	Actuation Temperature °C
LM1FA500-T40	40
LM1FA500-T50	50
LM1FA500-T60	60
LM1FA500-T70	70
LM1FA500-T80	80

Tech Sheet 110840

## ATEX Stop Ring SPDT IP65

### Top Entry, PG 09 DIN 43650 Connection

9025	Length mm
LM2FA100	100
LM2FA150	150
LM2FA200	200
LM2FA250	250
LM2FA300	300
LM2FA350	350
LM2FA400	400
LM2FA450	450
LM2FA500	500

Tech Sheet 110839

## DIY Kit Normally Closed IP65, 1" BSPP Male

### Top Entry, PG 09 DIN 43650 Connection

9025	Length mm
LM1TB-1000	1000
LM1TB-0500	500

Tech Sheet 110840

# FLOAT LEVEL SWITCHES

## Polypropylene Normally Open or Normally Closed

 **Working Temperature:**  
-10°C to +80°C

- Fluid specific gravity: >0.8
- Cable length: 300mm



**Side Entry, 1/2" NPT**

9025  
MFS10-N1-2

Tech Sheet 112

 **Working Temperature:**  
-40°C to +120°C

- Fluid specific gravity >0.8
- Cable length: 300mm



**Top Entry, 1/8" BSPP**

9025  
MFS17-C-2

Tech Sheet 112

## Stainless Steel Normally Closed IP65

- Normally open/normally closed contacts.
- Specific Gravity > 0.
- PG09 DIN 43650 connection

**stainless steel**



**Side Entry, BSPT Male**

9025  
RFS-12P-2-SUS304

Thread  
1/2"

Tech Sheet 111

# FLOAT LEVEL SWITCHES

**stainless steel**



## Stainless Steel Normally Closed IP65

 **Working Temperature:**  
-10°C to +80°C

 **Maximum Working Pressure:**  
10 bar

- Fluid specific gravity: ≥ 0.
- Maximum fluid viscosity 150 cS
- Cable length: 500mm



**Side Entry, BSPP Male**

9025  
LEM7A

Thread  
1/8"

 **Working Temperature:**  
-10°C to +80°C

 **Maximum Working Pressure:**  
10 bar

- Fluid specific gravity: ≥ 0.
- Maximum fluid viscosity 150 cS
- Cable length: 500mm



**Top Entry, BSPT Male**

9025  
LEM7NC

Thread  
1/8"

# LIQUID LEVEL GAUGES



## EcoFit Gauges

EcoFit liquid level gauges are available up to 1 metre, each gauge above 400mm is supplied with an upper tank bracket. Thread sizes available in G1/4", G3/8", G1/2" BSPP Male

- Suitable for many industrial and domestic usages, subject to pressure and material compatibility

**Maximum Working Temperature:** +60°C

### BSPP

0171	Thread	Centres mm
SEE80100	1/4"	100
SEE80125	1/4"	125
SEE80150	1/4"	150
SEE80200	1/4"	200
SEE80250	1/4"	250
SEE80300	1/4"	300
SEE80350	1/4"	350
SEE80400	1/4"	400
SEE80450	1/4"	450
SEE80500	1/4"	500
SEE80600	1/4"	600
SEE80650	1/4"	650
SEE80700	1/4"	700
SEE80750	1/4"	750
SEE80800	1/4"	800
SEE80850	1/4"	850
SEE80900	1/4"	900
SEE80950	1/4"	950
SEE801000	1/4"	1000
SEE82100	3/8"	100
SEE82125	3/8"	125
SEE82150	3/8"	150
SEE82200	3/8"	200
SEE82250	3/8"	250
SEE82300	3/8"	300
SEE82350	3/8"	350
SEE82400	3/8"	400
SEE82450	3/8"	450
SEE82500	3/8"	500
SEE82600	3/8"	600
SEE82650	3/8"	650
SEE82700	3/8"	700
SEE82750	3/8"	750
SEE82800	3/8"	800
SEE82900	3/8"	900
SEE821000	3/8"	1000
SEE84100	1/2"	100
SEE84125	1/2"	125
SEE84150	1/2"	150
SEE84200	1/2"	200
SEE84250	1/2"	250
SEE84300	1/2"	300
SEE84350	1/2"	350
SEE84400	1/2"	400
SEE84450	1/2"	450
SEE84500	1/2"	500
SEE84600	1/2"	600
SEE84650	1/2"	650
SEE84700	1/2"	700
SEE84750	1/2"	750
SEE84800	1/2"	800
SEE84900	1/2"	900
SEE841000	1/2"	1000

Tech Sheet 20616



**Pressure:** Atmospheric  
**Lower Body:** Brass, nickel plated  
**Fixing Bolts:** Brass, nickel plated  
**Seals:** Viton  
**Sight Tube:** Polycarbonate  
**Guard Tube:** Polycarbonate  
**Top Cap:** Brass  
**Adaptor:** Brass  
**Tank Seals:** Walkertite washer

## EasyFit Gauges

EasyFit liquid level gauges are available up to 1 metre. Suitable for many industrial and domestic usages, subject to pressure and material compatibility.

**Maximum Working Temperature:** +60°C

**Maximum Working Pressure:** 14 bar (subject to centre distance selected)

### BSPP

0171	Thread	Centres mm
SEE27100	1/4"	100
SEE27150	1/4"	150
SEE27200	1/4"	200
SEE27250	1/4"	250
SEE27300	1/4"	300
SEE27350	1/4"	350
SEE27400	1/4"	400
SEE27450	1/4"	450
SEE27500	1/4"	500
SEE27600	1/4"	600
SEE27650	1/4"	650
SEE27700	1/4"	700
SEE27800	1/4"	800
SEE27850	1/4"	850
SEE27900	1/4"	900
SEE27950	1/4"	950
SEE271000	1/4"	1000
SEE29100	3/8"	100
SEE29150	3/8"	150
SEE29200	3/8"	200
SEE29250	3/8"	250
SEE29300	3/8"	300
SEE29350	3/8"	350
SEE29400	3/8"	400
SEE29450	3/8"	450
SEE29500	3/8"	500
SEE29600	3/8"	600
SEE29650	3/8"	650
SEE29700	3/8"	700
SEE29800	3/8"	800
SEE29850	3/8"	850
SEE29900	3/8"	900
SEE29950	3/8"	950
SEE291000	3/8"	1000
SEE31100	1/2"	100
SEE31150	1/2"	150
SEE31200	1/2"	200
SEE31250	1/2"	250
SEE31300	1/2"	300
SEE31350	1/2"	350
SEE31400	1/2"	400
SEE31450	1/2"	450
SEE31500	1/2"	500
SEE31600	1/2"	600
SEE31650	1/2"	650
SEE31700	1/2"	700
SEE31800	1/2"	800
SEE31850	1/2"	850
SEE31900	1/2"	900
SEE31950	1/2"	950
SEE311000	1/2"	1000

Tech Sheet 20617



**Lower Body:** Brass  
**Fixing Bolts:** Brass  
**Seals:** Viton  
**Sight Tube:** Polycarbonate  
**Guard Tube:** Polycarbonate  
**Adaptor:** Brass  
**Tank Seals:** Dowty sealing washer

# LIQUID LEVEL GAUGES

## QuickFit Gauges

QuickFit liquid level gauges are available up to 1 metre.

- Suitable for many industrial and domestic usages, subject to pressure and material compatibility

**Maximum Working Temperature:** +65°C

**Maximum Working Pressure:** 3 bar

### BSPP

0171	Thread	Centres mm
SEE99100	1/4"	100
SEE99150	1/4"	150
SEE99200	1/4"	200
SEE99250	1/4"	250
SEE99300	1/4"	300
SEE99350	1/4"	350
SEE99400	1/4"	400
SEE99450	1/4"	450
SEE99500	1/4"	500
SEE99600	1/4"	600
SEE99650	1/4"	650
SEE99700	1/4"	700
SEE99800	1/4"	800
SEE99850	1/4"	850
SEE99900	1/4"	900
SEE99950	1/4"	950
SEE991000	1/4"	1000
SEE97100	3/8"	100
SEE97150	3/8"	150
SEE97200	3/8"	200
SEE97250	3/8"	250
SEE97300	3/8"	300
SEE97350	3/8"	350
SEE97400	3/8"	400
SEE97450	3/8"	450
SEE97500	3/8"	500
SEE97600	3/8"	600
SEE97650	3/8"	650
SEE97700	3/8"	700
SEE97800	3/8"	800
SEE97850	3/8"	850
SEE97900	3/8"	900
SEE97950	3/8"	950
SEE971000	3/8"	1000
SEE95100	1/2"	100
SEE95150	1/2"	150
SEE95200	1/2"	200
SEE95250	1/2"	250
SEE95300	1/2"	300
SEE95350	1/2"	350
SEE95400	1/2"	400
SEE95450	1/2"	450
SEE95500	1/2"	500
SEE95600	1/2"	600
SEE95650	1/2"	650
SEE95700	1/2"	700
SEE95800	1/2"	800
SEE95850	1/2"	850
SEE95900	1/2"	900
SEE95950	1/2"	950
SEE951000	1/2"	1000

Tech Sheet 20618

**Lower Body:** Brass, nickel plated

**Fixing Bolts:** Brass, nickel plated

**Seals:** Viton

**Sight Tube:** Polycarbonate

**Adaptor:** Brass

**Tank Seals:** Dowty sealing washer



## QuickMount Gauges

Available in G1/2", G3/4" BSPP male. G3/4" stainless steel model also.

### Without Valve, BSPP

0171	Thread	Centres mm
SEE22500P12	1/2"	500
SEE22550P12	1/2"	550
SEE22600P12	1/2"	600
SEE22650P12	1/2"	650
SEE22700P12	1/2"	700
SEE22750P12	1/2"	750
SEE22800P12	1/2"	800
SEE22850P12	1/2"	850
SEE22900P12	1/2"	900
SEE22950P12	1/2"	950
SEE221000P12	1/2"	1000
SEE221125P12	1/2"	1125
SEE221250P12	1/2"	1250
SEE221500P12	1/2"	1500
SEE221600P12	1/2"	1600
SEE221700P12	1/2"	1700

Tech Sheet 10435

### With Valve, Brass Fittings, BSPP

0171	Thread	Centres mm
SEE22280P	3/4"	280
SEE22400P	3/4"	400
SEE22500P	3/4"	500
SEE22600P	3/4"	600
SEE22610P	3/4"	610
SEE22710P	3/4"	710
SEE22750P	3/4"	750
SEE22770P	3/4"	770
SEE22800P	3/4"	800
SEE22825P	3/4"	825
SEE22850P	3/4"	850
SEE22880P	3/4"	880
SEE22900P	3/4"	900
SEE22950P	3/4"	950
SEE221000P	3/4"	1000
SEE221300P	3/4"	1300
SEE221400P	3/4"	1400

Tech Sheet 10435

### With Valve, Stainless Steel Fittings, BSPP

0171	Thread	Centres mm
SEE22S500P	3/4"	500
SEE22S550P	3/4"	550
SEE22S600P	3/4"	600
SEE22S1000P	3/4"	1000
SEE22S2800P	3/4"	2800
SEE22S4200P	3/4"	4200
SEE22S500B	3/4"	500
SEE22S550B	3/4"	550
SEE22S600B	3/4"	600
SEE22S650B	3/4"	650
SEE22S700B	3/4"	700
SEE22S750B	3/4"	750
SEE22S800B	3/4"	800
SEE22S850B	3/4"	850
SEE22S900B	3/4"	900
SEE22S1000B	3/4"	1000
SEE22S2800B	3/4"	2800

Tech Sheet 10435

The QuickMount valve assemblies are G3/4" BSPP which are manual screwdown with Auto Safety Shut-off (ASV) as the standard configuration, G1/2" BSPP does not come with the safety shut-off valve.

**Valves Assemblies:** Brass or stainless steel

**Collar:** Brass

**Seals:** Viton

**Sight Tube:** Polycarbonate

**Guard Tube:** 'C' section aluminium

**Tank Seals:** Walkertite washer

**Tank Seals:** Walkertite washer

**Tank Seals:** Walkertite washer

**Tank Seals:** Walkertite washer

**Maximum Working Temperature:** +100°C

**Maximum Pressure:** 14 bar





# VISUAL INDICATORS



## High Pressure Visual Indicators

- Indicate the presence or absence of a pneumatic signal
- Wide angle of visibility
- Contrasting colours combinations for positive identification

**Medium:**  
Compressed air, filtered dry or lubricate  
Operation: Visual indicator, diaphragm operated

**Materials:**  
Molded plastic body and internal components, brass connector, steel spring, synthetic rubber diaphragm

**° Operating Temperature:**  
+2°C to +66°C\*  
\*Consult our technical service for use below +2°C

**° Operating Pressure:**  
0.7 to 8.6 bar full actuation  
0-0.14 bar full de-actuation



### BSPP

0036	Unactuated Colour	Actuated Colour	Connection
5VS-401-800	Black	Red	G1/8
5VS-402-800	Black	Green	G1/8
5VS-410-800	Red	Black	G1/8
5VS-412-800	Red	Green	G1/8
5VS-420-800	Green	Black	G1/8
5VS-421-800	Green	Red	G1/8

Tech Sheet 71749

# COLD WATER FLOW METER

## Single-jet Water Meter

Compact design for most metering applications

**Meter Type:** Single-jet impeller design

**Meter Body Material:** Brass, epoxy coated

**Drinking Water Approved:** (75/33/EEC)

**Accuracy:** Class B

**Installation:** Horizontal or vertical

**Connection:** BSP (nuts, tails and washers supplied)

**° Maximum Working Temperature:**  
+30°C

**° Maximum Working Pressure:**  
16 bar



### Super Dry Dial

0241	Thread	Length	Gauge Diameter mm	LPM
WATERC1.5D	1/2"	110	15	1.5
WATERC2.5D	3/4"	130	20	2.5

Tech Sheet 10364

# THERMOMETERS FOR INDUSTRY

## Handheld Thermometers, Type K

- Free traceable Certificate of Calibration included
- Robust waterproof case offering IP66/67 protection
- Backlight, max/min and hold functions
- Integrated rubber seal for durability and complete watertightness
- Designed for reliability and ease of use
- Ideal for industry applications
- Excludes probe

 Working Temperature:  
-100°C to +1372°C



### Therma Waterproof

0065	Colour	IP Rating
232-101	Black	66/67
Tech Sheet 20016		

## K Type Probes



### To suit all Thermometers, K Type

0065	Probe Type
123-030	Ribbon Surface
123-046	Waterproof Surface
123-212	High Temperature
Tech Sheet 20069	

Please see tech sheet 20069 for all available K Type products

## Room Thermometers

- Accuracy +/- 1°C

 Working Temperature:  
-30°C to +50°C

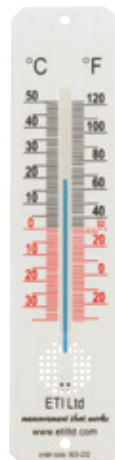

### Spirit-filled

0065	Description
803-232	White 200mm
803-233	Factory Act 200mm
Tech Sheet 10273	

## Bimetal Indicators

 Working Temperature:  
-30°C to +30°C



### 52mm Thermometer

0065	
800-100	
Tech Sheet 20615	

## Dial Pipe Thermometers

- Wrap-around stainless steel, spring mounting
- 50mm dial
- Stainless steel dial pipe thermometer, supplied with a wrap-around stainless steel spring kit (53mm long) that enables the user to mount each thermometer to a pipe
- For larger pipes it is possible to attach the thermometer to pipework using either tie wraps or wire (not supplied)



### 50mm Dial

0065	Temperature Range °C
800-951	0°C to +120°C
Tech Sheet 10271	

## Magnetic Dial Thermometers

- 50mm dial
- Stainless steel dial thermometer incorporating a magnetic sensing pad for mounting on ferrous metals



### 50mm Dial

0065	Temperature Range °C
800-950	0°C to +120°C
Tech Sheet 10272	

**ET PRO**

For Diesel Transfer Pumps  
Drain Valves see page 1636

